



NUFLO MC SYNERGY

Explosion-proof Totalizer

Hardware Manual

Document No. 50357267

IMPORTANT SAFETY INFORMATION

SYMBOLS AND TERMS

DANGER

Practices or circumstances that can lead to death or catastrophic property damage or economic loss.

WARNING

Practices or circumstances that can lead to serious personal injury, property damage, or economic loss.

ELECTRICAL SHOCK WARNING

An electrical hazard which will result in personal injury if instructions are not followed.

CAUTION

A hazardous situation which can lead to minor or moderate injury, property damage, or economic loss.

Important Non-urgent information that may impact the outcome of a process or procedure.

Note Additional information or a tip that may help the user to work more efficiently.

DO NOT DISCARD IN TRASH CAN

Product should not be discarded as unsorted waste. It must be sent to separate collection facilities for recovery and recycling.

CONTACT SENSIA

For technical support, please refer to <https://www.sensiaglobal.com/Technical-Support>.

For all other inquiries, please refer to <https://www.sensiaglobal.com/Customer-Care> or dial 1-866-773-6742.

REVISION HISTORY

Revision	Description of Change	Issuer	Approver	Date
01	Release to production	KM	TMM	5-11-2023
02	Correction to ATEX/IECEX conditions for safe use, page 34, and Enron Event Counter register description, page C-35.	KM	TMM	6-5-2023
03	Content updated to reflect feature upgrades to the Digital Data Plate mobile application.	KM	TMM	4-17-2026

PUBLISHER NOTES

DISCLAIMER

While Sensia has taken every care in the preparation of this document, it cannot accept responsibility for printing errors or omissions and does not warrant that it is correct and comprehensive in every particular instance. Equipment supplied should always be operated by persons with an appropriate level of skill and training.

Sensia shall not be liable for incidental or consequential damages resulting from the furnishing, performance or use of this material.

Sensia pursues a policy of continuous improvement, and information given herein may be updated without notice. Further, this information is proprietary to Sensia, and must not be disclosed to any third party except as may be required to operate the equipment supplied in accordance with the purposes for which it was sold by the persons properly licensed to operate it.

COPYRIGHT NOTICE

Copyright © 2026 Sensia. All rights reserved.

This work contains the confidential and proprietary trade secrets of Sensia and may not be copied or stored in an information retrieval system, transferred, used, distributed, translated or retransmitted in any form or by any means, electronic or mechanical, in whole or in part, without the express written permission of the copyright owner.

TRADEMARKS & SERVICE MARKS

Sensia, the Sensia logotype, and other words or symbols used to identify the products and services described herein are either trademarks, trade names or service marks of Sensia and its licensors, or are the property of their respective owners. These marks may not be copied, imitated or used, in whole or in part, without the express prior written permission of Sensia. In addition, covers, page headers, custom graphics, icons, and other design elements may be service marks, trademarks, and/or trade names of Sensia and may not be copied, imitated, or used, in whole or in part, without the express prior written permission of Sensia.

WARRANTY

Product warranty is specified in Sensia Terms and Conditions at the time of purchase.

SECURITY NOTICE FOR SOFTWARE PRODUCTS

The software described herein is designed to operate with the minimum hardware and operating system specifications recommended by Sensia. The software should be operated in a secure environment whether operation is performed across a network, on a single system and/or on multiple systems.

The end user is responsible for configuring and maintaining networks and/or system(s) in a secure manner. The end user is also responsible for obtaining, installing, operating and maintaining all hardware, other equipment and third party software required for use of the software. Sensia is not responsible for data loss arising as a result of software use or interaction of the software with any third party software.

For more information about recommended security practices, please contact Sensia Technical Support via <https://www.sensiaglobal.com/Technical-Support>.

Page intentionally left blank

Table of Contents

Section 1: Introduction	9
User Documents.....	9
Operation.....	9
Product Identification.....	10
Specifications	11
Key Product Features.....	14
LCD.....	15
Through-the-Glass Keypad Navigation.....	17
Bluetooth Application	18
Linear and Multipoint Linearization	19
Calibration Correction with Meter Factors.....	19
Multiple Power Supply Options.....	20
Gas Volume Correction.....	20
Programmable Input Signal Options.....	21
Multiple Output Options	21
Alarms.....	21
Flow Log Archival.....	27
Event and Alarm Log Archival.....	28
Password-Protected Security.....	28
Optional Features.....	28
Explosion-Proof Communications Adapter	28
RS-485 IS Barrier.....	28
Analog Output and HART Communication via Expansion Board.....	28
Ethernet Communication via Expansion Board	29
Commonly Used Functions	29
Reading Totals	29
Saving Totals to Memory.....	29
Resetting the Total	29
Section 2: Installation	33
Hazardous Area Installations (ATEX/IECEX).....	34
Conditions for Safe Use (ATEX/IECEX).....	34
Mounting Options (ATEX/IECEX).....	35
Hazardous Area Installations (CEC/NEC).....	37
Conditions for Safe Use (CEC/NEC).....	37
Installing the MC Synergy EXP	39
Field Wiring.....	39
Power Supply Options.....	40
Internal Power Supply.....	40
External Power Supply.....	40
Loop Power (Analog Output/HART Expansion Board)	40
Ethernet Power (Ethernet Expansion Board).....	40
Input Wiring	42
Reset Input.....	42
Turbine Flowmeter (TFM) Input	43
Pulse Input	43
Contact Closure	44
Output Wiring.....	44
Digital Output	44

Analog Output (Expansion Board required)	46
HART Point-To-Point or Multidrop (Expansion Board required).....	46
Ethernet Communication (Expansion Board Required)	48
RS-485 Output	48
Software Installation and Connection	51
Installation	51
Connect to the MC Synergy	51
Section 3: Device Configuration via the Keypad.....	53
Operating Mode	53
Exit a Configuration Menu	55
Acknowledge Active Alarms.....	55
Clear the Grand Total	56
Configure the Display	56
Configure the Display - Shortcut	58
Configure More Display Parameters	58
Configure Device Date and Time.....	59
Configure Communication Ports.....	60
Configure Port 1	60
Configure Port 2	60
Configure a 4-20 mA Rate Output	61
Configure the HART Interface	63
HART Alarm Troubleshooting.....	66
Configure Ethernet Communication	67
Enable/Reset Bluetooth Communication.....	68
Connect to MC Synergy via Bluetooth.....	69
Configure Input Type, Sensitivity and Meter Kit Alarm	70
Sensitivity Measurement.....	70
Meter Kit Alarm	70
Monitor Meter Kit Life.....	71
Configure the Pulse Output	72
Load Default Values	73
Enter Meter Factors.....	74
Linear Meter Factor.....	74
Multi-Point Meter Factor.....	75
Enter K-Factors	77
Linear K-Factor	77
Multi-Point K-Factor	78
Section 4: Maintenance.....	81
Lithium Battery Replacement	81
Alkaline Battery Replacement	83
Circuit Assembly Replacement.....	84
MC Synergy Spare Parts (CEC/NEC)	86
MC Synergy Spare Parts (IEC/ATEX)	87
Appendix A—Hardware Options	A-1
Explosion-Proof Reset/Control Switch.....	A-1
Installation.....	A-1
Operation	A-1
Explosion-Proof RS-485 Communications Adapter.....	A-2
Assembly of the Plug Connector.....	A-2
User-Supplied Accessories	A-3

Connecting to the Communications Adapter.....	A-3
Disconnecting the Communications Adapter.....	A-4
Installation of Adapter (when purchased separately).....	A-4
USB Communications Adapter.....	A-5
User-Supplied Hardware.....	A-6
Using the Adapter.....	A-6
Covering the Adapter.....	A-6
Adapter Kit Installation.....	A-6
Installing an Expansion Board.....	A-7
Appendix B—Lithium Battery Information.....	B-1
Lithium Battery Disposal.....	B-1
Transportation Information.....	B-1
Customer Support.....	B-1
Appendix C—Modbus Protocol.....	C-1
Introduction.....	C-1
Supported Commands.....	C-1
Data Types.....	C-1
Registers.....	C-2
System Configuration.....	C-9
Product Code (register 1000).....	C-10
Firmware/Register Table Version Numbers (registers 1001, 1002).....	C-10
Manufacture Date/Sales Date (registers 1003, 1004).....	C-10
Slave Address (register 1009).....	C-10
Baud Rate (register 1010, 1102, 1109).....	C-10
Input Configuration.....	C-12
Turbine Meter Input Configuration.....	C-14
Output Configuration.....	C-16
Holding Registers 7000 Series.....	C-20
Base Units/Configured Units.....	C-23
Conversion Factors.....	C-23
Polling Registers.....	C-24
Interval/Daily/Event Pointer (registers 17001 through 17006).....	C-24
Real Date (registers 17007, 17008).....	C-24
Real Time (registers 17009, 17010).....	C-24
Totals.....	C-25
Active K-Factor (register 8286).....	C-25
Active Meter Factor (register 8288).....	C-25
Holding Registers 8000 Series.....	C-25
Holding Registers 17000 Series.....	C-32
Command Registers.....	C-34
Log Data.....	C-35
Appendix D—HART Communications.....	D-1
Overview.....	D-1
Introduction.....	D-1
Device Identification.....	D-1
HART Commands.....	D-1
Universal Commands.....	D-1
Common Practice Commands.....	D-2
Command 73 – Find Device.....	D-2
Device-Specific Commands.....	D-3
Burst Mode.....	D-3

Catch Device Variable.....	D-3
Variables and Status.....	D-4
Device Variables	D-4
Dynamic Variables	D-4
Status Information.....	D-5
Device-Specific Command Descriptions	D-8
Command 128 – Read Alarms.....	D-8
Command 129 – Read Power.....	D-10
Command 130 – Set Write Protection.....	D-10
Command 131 – Publish Polling Registers.....	D-11
Command 132 – Clear Grand Total	D-11
Command 133 – Read K-Factor Configuration.....	D-12
Command 134 – Write K-Factor Configuration.....	D-13
Command 135 – Read Meter Factor Configuration	D-15
Command 136 – Write Meter Factor Configuration	D-17
Command 137 – Read Input Channel Configuration and Meter Characteristics	D-19
Command 138 – Write Input Channel Configuration and Meter Characteristics	D-20
Command 139 – Read Runtime	D-21
Command 140 – Read Flow Rate Trim Digital to Analog Converter.....	D-22
Command 141 – Reset Analog Output Trim	D-22
Command 142 – Read Site / Well Name	D-23
Command 143 – Write Site / Well Name	D-23
Command 144 – Read Password Protection Status.....	D-24
Command 145 – Change Password.....	D-24
Command 146 – Read Display Unit Configuration	D-25
Command 147 – Write Display Unit Configuration.....	D-25
Unit Sets.....	D-26
Flow Rate Unit Codes	D-26
Volume Unit Codes	D-27
K-Factor Unit Codes	D-27
Temperature Unit Codes	D-27
Voltage Unit Codes	D-28
Length Unit Codes	D-28
Performance.....	D-28
Sampling Rates.....	D-28
Power-Up.....	D-29
Reset.....	D-29
Self-Test.....	D-29
Command Response Times.....	D-29
Busy and Delayed Response.....	D-29
Long Messages.....	D-30
Modes	D-30
Write Protection.....	D-30
Damping.....	D-30
Capabilities & Default Configuration.....	D-30
Capability Checklist.....	D-30
Default Configuration	D-31

Section 1: Introduction

The Sensia NUFLO MC Synergy Explosion-proof Totalizer (Figure 1.1) packs a full spectrum of gas and liquid measurement functionality, high-speed performance, and log archive and retrieval capabilities in an easy-to-use, explosion-proof totalizer. Commonly used operations can be accessed through the glass of the enclosure lid with five capacitive buttons or via Sensia's Digital Data Plate app for mobile devices. A PC software application also provides access to all configurable parameters, allowing you to calibrate and configure the unit quickly and easily.



Figure 1.1—MC Synergy EXP Totalizer

USER DOCUMENTS

See the MC Synergy Software Manual and MC Synergy QuickStart Guide for detailed descriptions of the PC software interface and the Digital Data Plate mobile application, respectively.

OPERATION

The MC Synergy calculates and displays instantaneous flow rates and accumulated totals based on a turbine flowmeter input signal. The MC Synergy's microprocessor circuitry counts the pulses generated by a companion flowmeter, converts that data into volume and rate values in accordance with calibration settings, and displays the totalized data on the LCD. The eight-digit top readout indicates total flow volume, and the six-digit bottom readout indicates flow rate. Up to 384 daily logs, 768 interval logs, 768 alarm logs, and 768 event logs can be archived and accessed on demand.

The MC Synergy is one of the most versatile totalizers on the market, offering a variety of user-configurable display options, input and output options, Modbus, Bluetooth®, flow logging, turbine flowmeter linearization, and optionally, HART® and Ethernet communication. For specifications, see [Table 1.1, page 11](#).

An optional explosion-proof reset switch further expands the unit’s versatility, making it possible to reset the total without opening the enclosure. The reset switch can also be configured to remotely advance the display, clear unacknowledged alarms, create a partial record, or publish polling registers.

An optional USB adapter facilitates the connection to the PC software for the most extensive configuration selections.

For those who prefer the convenience of wireless access, the Sensia Digital Data Plate app utilizes Bluetooth communication to enable users to configure, calibrate, and check operational status of their MC Synergy device from a tablet or smart phone.

PRODUCT IDENTIFICATION

Each device is labeled with a serial tag that identifies the product by part number and serial number and specifies the device’s input power requirements and safety classification. The CEC/NEC-compliant device is marked as shown in [Figure 1.2](#). The ATEX/IECEX-compliant device is marked as shown in [Figure 1.3](#). A description of the electrical protection afforded by CSA certification and associated safety markings are also shown in [Figure 1.3](#).

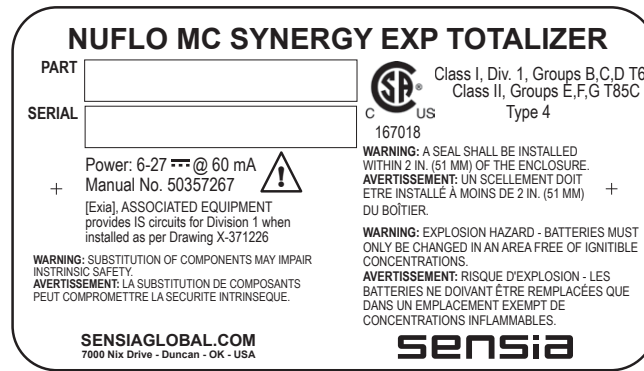

Figure 1.2—Serial tag for device compliant to CEC/NEC standards

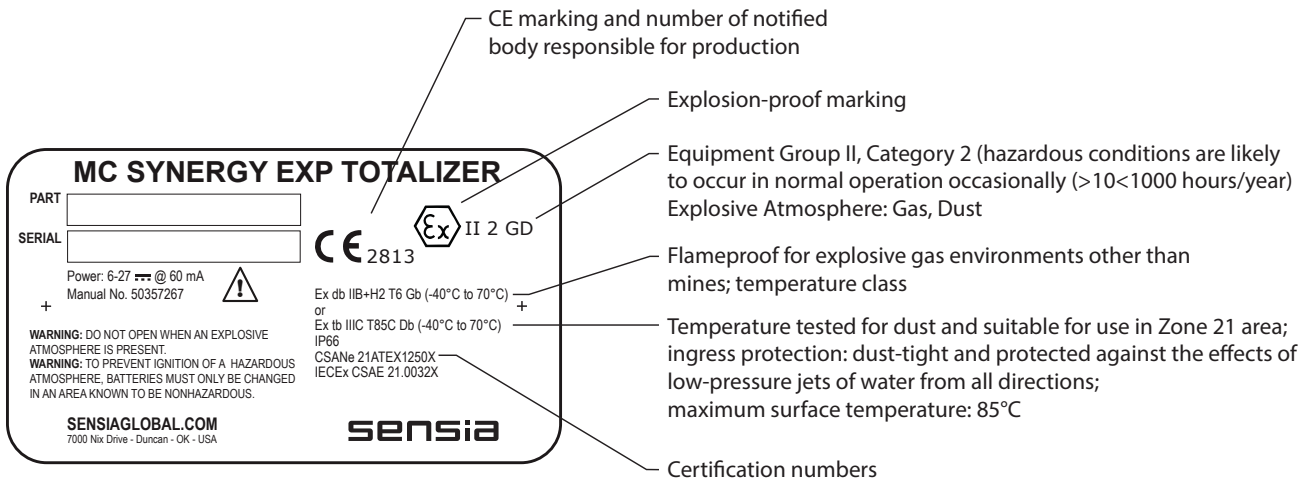

Figure 1.3—Serial tag for device compliant to ATEX/IECEX standards

SPECIFICATIONS

TABLE 1.1—MC SYNERGY EXP TOTALIZER SPECIFICATIONS

Electrical Safety Classification	Approved by CSA for US and Canada: Class I, Div. 1, Groups B, C, D, T6 (explosion-proof) Class II, Div. 1, Groups E, F, G, T85C Class III Type 4 enclosure Tamb: -40°C to 70°C (lithium-powered) Tamb: -18°C to 55°C (alkaline-powered)	
	ATEX/IECEX: ATEX CSANe 21ATEX1250X IECEX CSAE 21.0032X  II 2 GD Ex db IIB+H2 T6 Gb Ex tb IIIC T85°C Db IP66 Tamb: -40°C to 70°C (lithium-powered)	
	EMC - Complies with EMC Directive 2014/30/EU and the Radio Equipment Directive (RED) 2014/53/EU	
	RoHS-EU Directive 2011/65/EU, 2015/863 (RoHS 3)	
	Enclosure	
Enclosure	Cast aluminum (less than 0.05% copper), painted with epoxy and polythylene, with single window is standard Stainless steel, optional	
Weight	4.75 pounds (typical)	
Environmental	Maximum relative humidity: 80% Altitude: Up to 2000 m, maximum Pollution degree: 3 Overvoltage category: I	
System Power	Internal power	Up to two 3.6 VDC, D-size lithium batteries (2-year life is typical for a single battery). Transport is restricted. Batteries can be used as primary power source and an automatic back-up of an external source. (External power is required when Ethernet or HART/4-20 mA expansion boards are in use.) Alkaline battery pack containing 3 C-size industrial-grade batteries (for use only in devices with North America approval) The energy within the pack (pack's service life) is half the energy of a single lithium "D" cell." Transport is unrestricted.
	Clock battery	A lithium coin cell powers the real-time clock when no other power source is connected. See also Real-Time Clock specifications.
	External power	Expanded operation, including Ethernet or HART & 4-20 mA require an external power source. External power supply: 6 to 27 VDC @ 60 mA max. (reverse polarity protected), 5 mA typical 4-20 mA & HART expansion board - loop power supply: • 12.5 to 27 VDC @ 22 mA max. with internal battery backup (reverse polarity protected) • Load loop resistance: 725 ohms @ 27 VDC; 575 ohms @ 24 VDC Ethernet expansion board: 6 to 27 VDC @ 60 mA max. (reverse polarity protected)

TABLE 1.1—MC SYNERGY EXP TOTALIZER SPECIFICATIONS

	<p>WARNING Housing temperature must not exceed 70 °C (158 °F). Excessive temperatures, which could result from ambient conditions combined with radiated and conductive heat from the process, could cause the internal lithium battery to ignite or explode.</p>						
Operating Temperature	<p>Lithium-Powered: -40°C to 70°C (-40°F to 158°F) Alkaline-Powered: -18°C to 55°C (0°F to 130°F) Display contrast is reduced at temperatures below -20°C (-4°F)</p>						
LCD	<p>Two display modes:</p> <ul style="list-style-type: none"> • Display rate and total • Display up to 8 user-selected parameters (grand total, current day, previous day, current interval, previous interval, etc. (configurable via PC software or Sensia Digital Data Plate app)) <p>Total units of measurement are user-selectable: BBL, GAL, LIT, M3, CF, SCF, any unit x 1000</p> <p>Rate units of measurement are user-selectable: BBL, GAL, LIT, M3, CF, SCF (per DAY, HR, MIN, SEC), any unit x 1000 (per DAY, HR, MIN, SEC)</p>						
Real-Time Clock	<p>Clock display format: Day, Month, Year, Hour, Minute, Second</p> <p>Accuracy: 3.5 PPM Tolerance and drift over temperature: 1.84 minutes / year</p> <p>A lithium coin cell battery powers the clock when no other power source is connected. The coin cell is user-replaceable in a non-hazardous area. Transport is unrestricted (less than 0.01 g lithium).</p> <p>Battery retention period: 1.75 years with active use; 10 years in backup/standby mode</p>						
User Interface	<p>Configure the MC Synergy with any of three user interfaces. Most selections are supported by all three; some are available only in PC software and/or the Digital Data Plate app.</p> <table border="0" data-bbox="394 1041 1427 1528"> <tr> <td data-bbox="394 1041 613 1192">Keypad</td> <td data-bbox="621 1041 1427 1192"> <p>Through-the-glass keypad navigation via 5 capacitive buttons. Button sensitivity is adjustable. Duplicate set of tactile mechanical buttons are accessible with the lid removed. User-configurable front panel security/lock code</p> </td> </tr> <tr> <td data-bbox="394 1199 613 1402">Mobile app</td> <td data-bbox="621 1199 1427 1402"> <p>The Bluetooth-enabled Sensia Digital Data Plate app is compatible with iOS and Android operating systems (8 dBm, 2400 to 2483.5 MHz) BLE 5 compliant Wireless (Bluetooth) connection can be disabled via the keypad or PC software Optional 6-digit pairing code is software-configurable for added security User-configurable session period (default is 5 min)</p> </td> </tr> <tr> <td data-bbox="394 1409 613 1528">PC software</td> <td data-bbox="621 1409 1427 1528"> <p>Full-featured MC Synergy interface software is free of charge and downloadable from the Sensia website. Sensia's ScanData software simplifies data analysis by allowing you to view, print, and export logged data.</p> </td> </tr> </table>	Keypad	<p>Through-the-glass keypad navigation via 5 capacitive buttons. Button sensitivity is adjustable. Duplicate set of tactile mechanical buttons are accessible with the lid removed. User-configurable front panel security/lock code</p>	Mobile app	<p>The Bluetooth-enabled Sensia Digital Data Plate app is compatible with iOS and Android operating systems (8 dBm, 2400 to 2483.5 MHz) BLE 5 compliant Wireless (Bluetooth) connection can be disabled via the keypad or PC software Optional 6-digit pairing code is software-configurable for added security User-configurable session period (default is 5 min)</p>	PC software	<p>Full-featured MC Synergy interface software is free of charge and downloadable from the Sensia website. Sensia's ScanData software simplifies data analysis by allowing you to view, print, and export logged data.</p>
Keypad	<p>Through-the-glass keypad navigation via 5 capacitive buttons. Button sensitivity is adjustable. Duplicate set of tactile mechanical buttons are accessible with the lid removed. User-configurable front panel security/lock code</p>						
Mobile app	<p>The Bluetooth-enabled Sensia Digital Data Plate app is compatible with iOS and Android operating systems (8 dBm, 2400 to 2483.5 MHz) BLE 5 compliant Wireless (Bluetooth) connection can be disabled via the keypad or PC software Optional 6-digit pairing code is software-configurable for added security User-configurable session period (default is 5 min)</p>						
PC software	<p>Full-featured MC Synergy interface software is free of charge and downloadable from the Sensia website. Sensia's ScanData software simplifies data analysis by allowing you to view, print, and export logged data.</p>						
Logging	<p>384 daily logs, 768 interval logs, 768 event logs, & 768 alarm logs Interval period: user-defined, 1 minute to 12 hours (default is 1 hour) Flow archive contents: 7 user-defined parameters plus device status</p>						

TABLE 1.1—MC SYNERGY EXP TOTALIZER SPECIFICATIONS

Inputs	Turbine Meter Input (raw AC signal) Configurable sensitivity via keypad Sensitivity selections: 20 mV P-P, 50 mV P-P, and 100 mV P-P Frequency range: 0 to 5000 Hz Calibration: linear or 12-point calibration factors Meter factor correction: linear or 12-point meter factors	
	Pulse Input (typically from a turbine pre-amplifier) Logical high must be 3 to 27 VDC Frequency range: 0 to 5000 Hz	
	Contact Closure Input Dry contact 100 kΩ pullup to 2.8 VDC with debounce filtering	
	Remote Reset Input 3 to 27 VDC Enabled via pulse or contact closure Pulse duration > 3 seconds to reset grand total 22.1 kΩ pullup to 2.8 VDC for contact closure Input can be configured via PC software (device interface setup settings) to clear alarms, create a partial record, or publish a polling total.	
Digital Outputs	Two isolated Digital Outputs Output rating: 60 mA max. @ 27 VDC, on-state drop = 0.057 VDC @ 60 mA, 0.007 VDC @ 10 mA, open drain transistor output Outputs can be independently assigned to the following configurations.	
	Frequency	Amplified frequency output of turbine meter input signal: 0 to 5000 Hz
	Volumetric Pulse	Configurable pulse width (duration): 10 to 60,000 ms
	Alarm (Status)	Output of process conditions or measurement health Selectable for multiple alarm conditions ORed or ANDed together Latching or non-latching Normally open or normally closed
	Controlled by Modbus	Modbus write to digital register will change the state to ON/OFF
Analog Output (Optional)	Optional expansion board supports two-wire transmitter and wired HART protocol	
	Loop power: 12.5 to 27 VDC	
	Two-wire transmitter	4 to 20 mA isolated, loop-powered Accuracy (after 2-point calibration): ± 0.1% of span maximum error at 25 °C (77 °F) Temperature drift: ±50 ppm/°C (±27.8 ppm/°F) Resolution: 16 bits Zero and full-scale values configurable from keypad Update period: 1 second Represents flow rate
	Wired HART communications	HART registered product Protocol revision 7.6 Supports point-to-point, multidrop, and burst modes 14 device variables 4 mappable dynamic variables (SV,TV,QV) – flow rate is always primary variable Device description file can be downloaded from www.fieldcommgroup.org

TABLE 1.1—MC SYNERGY EXP TOTALIZER SPECIFICATIONS

Ethernet (Optional)	<p>Optional expansion board supports Modbus TCP/IP (Port 502) and Modbus Over TCP (Port 503) Protocol: Class 0 of the Standard IEEE 802.3 protocol Speed: 10/100 Mbits/sec IP Version: IPV4 External power input required</p> <p>Connection DHCP or static User-selectable MTU fragmentation RJ-45 connector Auto-negotiate to select the highest link-up speed 2 connections to each port Each connection supports up to 16 queued messages</p>
Modbus	<p>RS-485: RTU mode Modbus supports 16-bit and 32-bit register sizes Baud rates: 300, 1200, 2400, 4800, 9600, 19200, 38400, and 57600 Optional external communications adapter simplifies PC connection. Mounts in enclosure conduit opening and is suitable for hazardous locations.</p> <ul style="list-style-type: none"> • USB type (compliant to CEC/NEC standards) • RS-485 type (compliant to IEC and ATEX standards) <p>Optional RS-485 safety barrier with conduit seal is approved for use in intrinsically-safe installations Ethernet: Modbus TCP, Modbus Over TCP</p>
Enron Modbus	<p>Enron-compliant download of daily, interval, alarm and event records. Flow archive contents include 7 configurable values, timestamp, and device status.</p>
PC Requirements for Software	<p>Operating system: Windows 10 or later Display: 1280 x 800, 16-bit (thousands of colors) color display or greater Internet connection for web links, software downloads, tech support Communications port: USB 2.0, physical, or virtual serial port</p>

KEY PRODUCT FEATURES

This section presents an overview of button features of the MC Synergy EXP Totalizer. Many of these features are discussed in more detail in [Section 3: Device Configuration via the Keypad, page 53](#).

Key features discussed here include:

- LCD
- Through-the-glass keypad navigation
- Bluetooth with iOS & Android compatible application
- Multiple power supply options
- Linear and multipoint linearization
- Calibration correction
- Gas volume correction
- Programmable input signal options
- Multiple output options
- Alarms: user-configurable turbine alarms and system alarms
- Flow log archival & event and alarm log archival
- Password-protected security
- Options: explosion-proof adapter, RS-485 IS barrier, analog output/HART, or Ethernet communication
- Reading totals, saving totals, and resetting totals

LCD

The LCD (Figure 1.4) provides a simultaneous indication of accumulated total (top readout) and flow rate (bottom readout) in the standard operating mode.

When you enter configuration mode, the name of the menu option selected appears in the lower (rate) display, and settings are entered in the top (total) display.

Flow volume can be measured in barrels, gallons, liters, cubic meters, or cubic feet.

A multiplication factor is also available for indicating flow volume in terms of 1,000 units. The unit of measure for the Total readout and the decimal point position are selected by the operator during calibration.



Figure 1.4—Total and Rate are displayed by default. Selected units of measurement are displayed to the right of the total and rate values.

Flow rate can be measured in a variety of pre-programmed units. The flow rate unit of measure is selected in two steps: (1) a volume unit is chosen and (2) a time-base unit (per day, per hour, per minute, or per second) is chosen. Users can choose any combination of pre-programmed volume and time units in establishing the flow rate engineering unit (for example, gallons per hour, gallons per day, or gallons per minute). The volume unit used for the flow rate can be different from the unit used to read Total volume. The unit of measure for the Rate readout and the decimal point position are user-selected.

Volume and Flow Rate Display

By default, the MC Synergy displays the grand total and flow rate on the LCD. The decimal position on the accumulated volume is configurable from tenths to ten-thousandths (one to four decimal positions). For example a Grand Total of 104.9 BBL with **one** decimal appears as 104.9 BBL. The same number configured with **two** decimals appears as 104.90 BBL. If the accumulated volume reaches 1000000.00, the number of digits will exceed the display capacity and the value will appear as 000000.00 (the left-most digit is cut off from view). Internally, the accumulated volume will roll over at 10M user units regardless of the decimal setting.

If more decimal positions are desired to show greater precision, select the x1000 unit selection for volume.

By default, the flow rate is displayed with two decimals and the LCD will show values up to 9999.99. When the rate reaches 10000.00, the decimal position automatically changes from two decimals to one decimal to accommodate the extra digit and appears as 10000.0.

If you desire a fixed decimal configuration for flow rate, log into the PC software and enable the “Suppress Automatic Rate Decimal” setting. This setting can be found by selecting the Configure Device menu tab and clicking on the Device Interface tile. In this configuration, the decimal position you select will remain constant regardless of changes in flow rate value. When the rate value surpasses 6 digits (including decimals), the message “OVERUN” will appear in the bottom row of the LCD where the rate normally appears (Figure 1.5, page 16).

To clear this error, reduce the number of decimal places using the keypad Display menu (for example, display rate in tenths rather than hundredths), enable the “x1000” unit setting for the rate display, or change the unit of measurement.

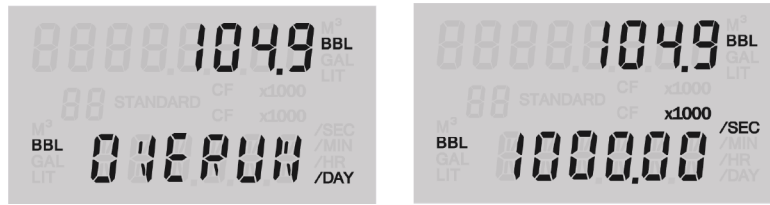

Figure 1.5—A flow rate overrun can be alleviated by using the X1000 unit selection for displaying rate.









Status Alert

A two-digit alphanumeric code may appear in the LCD to alert the operator to a variety of status changes. [Figure 1.4, page 15](#) shows the location of the Status Alert. See [Table 1.2](#) for a description of commonly displayed status alert codes.

TABLE 1.2—STATUS ALERT DISPLAY CODES

Definition	Code	Display
Device is reset due to power cycle (power on)	PO	PO
Elapse of watchdog timer due to PC software or hardware fault causing a device reset	RE	RE
Device battery is low and should be changed	BL	BL
Bluetooth module is available for pairing	PA	PA
Bluetooth module is active (on)	BO	BO
Edit mode, activated when you enter a configuration menu containing editable units of measure or decimal positions	ED	ED
An Ethernet option board is installed	IP	IP
Communications port selected for configuration (COMM1=P1)	P1, P2	P1
Digital output selected for configuration	d1, d2	d1
Numeric indicator for distinguishing calibration points when entering a multi-point meter factor or K-factor	01, 02...	01

TABLE 1.2—STATUS ALERT DISPLAY CODES

Definition	Code	Display
<p>A turbine health vulnerability has been detected. Indicators will appear in the flow volume display and trigger conditions are defined in Table 1.3, page 24.</p> <p>bb = bent blade Lb = lost blade ES = erratic signal</p>	bb, Lb, ES	  
<p>The meter has exceeded established min or max operating conditions. Alerts are supported for low-low, low, high, and high-high setpoints.</p> <p>Alerts may be applied to turbine alarms as defined in Table 1.3, page 24, or to user-defined alarms as defined in Table 1.5, page 27.</p>	LL, Lo, hl, hh	   
<p>A user-defined alarm is unacknowledged. The indicator does not apply to predefined turbine alarms.</p>	uA	

See also a list of alarm descriptions in [Turbine Alarms Detail, page 24](#), [System Alarms, page 26](#), and [User-Defined Alarms Detail, page 27](#).

THROUGH-THE-GLASS KEYPAD NAVIGATION

Five capacitive buttons on the keypad allow users to configure basic functions. [Figure 1.6, page 18](#), summarizes the functions supported by each button. Most parameters can be configured in seconds by selecting the KFACT or MENU button, navigating settings with the INC or STEP buttons, and saving selections with the ENTER button.

[Section 3: Device Configuration via the Keypad, page 53](#) contains step-by-step procedures for configuring the totalizer with the keypad.

In operating mode, a tap of the INC button triggers a scroll of system status values including firmware version, date and time, temperature, voltage, battery status, etc. If the Ethernet option board is installed, the IP address will be included. If the analog output option board is installed, loop voltage will be displayed.

Note Remove gloves before operating the keypad through the glass. The device may have difficulty detecting button presses if you are wearing gloves.

Note The MC Synergy's through-the-glass navigation auto-calibrates its sensitivity to your touch. However, if this is not adequate, you can make additional sensitivity adjustments using the keypad menu. See [Configure the Display, page 56](#). If you are in a non-hazardous area, you can also remove the lid and use tactile menu buttons around the perimeter of the display.

Important Some configuration parameters are accessible only through the PC software. See the MC Synergy Software User Manual for instructions.

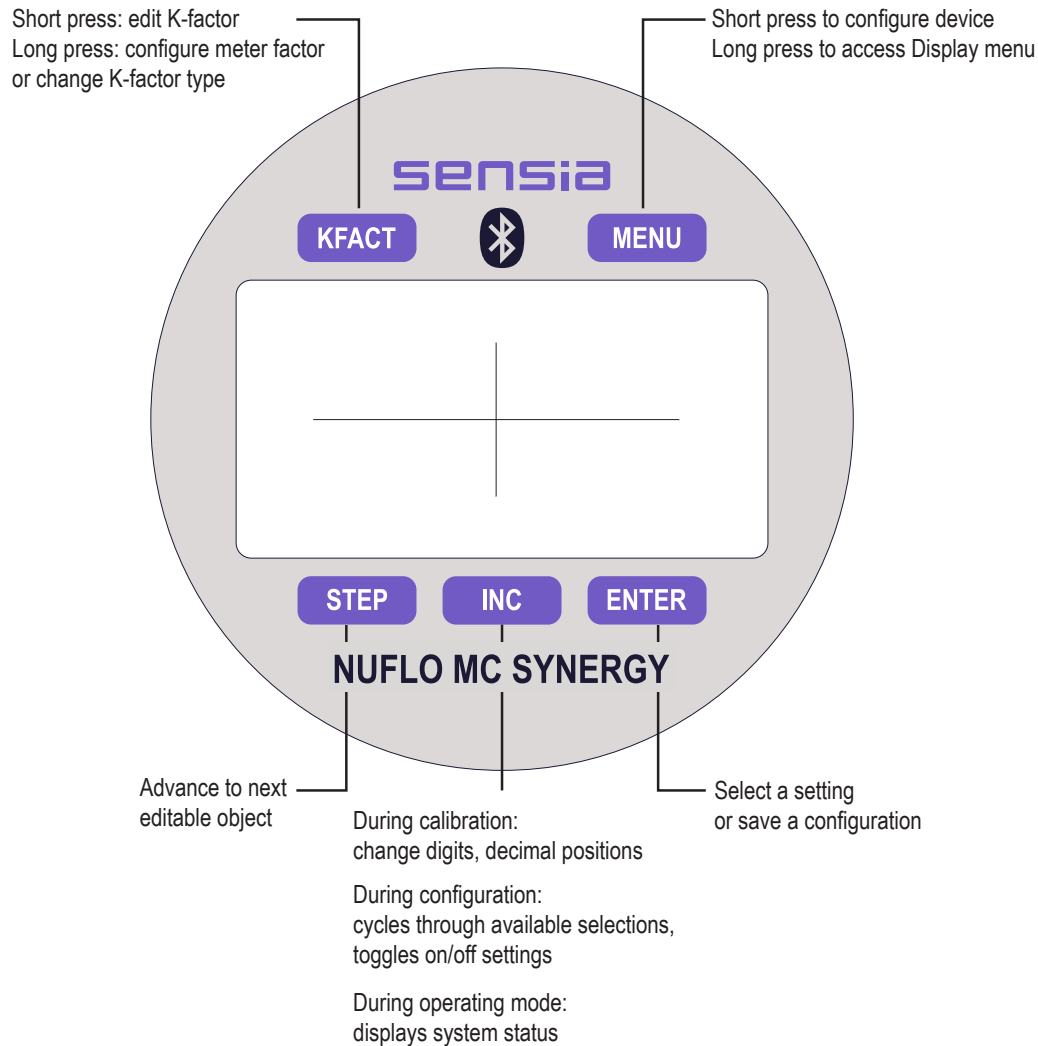

Figure 1.6—Keypad functions

BLUETOOTH APPLICATION

Sensia's mobile app, the Digital Data Plate, communicates with the MC Synergy via Bluetooth and allows you to perform basic configuration with a smart phone or tablet. The application is useful for uploading calibration data from a NUFLO or BARTON turbine meter using the QR code provided with the meter. It also allows viewing of real-time status. Bluetooth allows for quick and easy communication with the device, and the implemented security features provide protection from unauthorized access. The Bluetooth module powers down automatically, optimizing battery life. The Bluetooth pairing process is enabled via the keypad, which restores power to the module. The transmitter remains enabled as long as the connection is active and expires when the session period ends. The session period is 5 minutes by default but is user-configurable to allow shorter or longer periods.

For more information on configuration, see [Enable/Reset Bluetooth Communication, page 68](#). For more information on connection and communication, see [Connect to MC Synergy via Bluetooth, page 69](#).

LINEAR AND MULTIPOINT LINEARIZATION

The MC Synergy supports single-point linear calibration or multi-point calibration with 2 to 12 calibration points, based on the K-factor provided with the turbine flowmeter. This can be configured through the keypad or PC software. Calibration data can also be uploaded with a mobile smart phone or tablet by using the Digital Data Plate application to scan a QR code supplied with a NUFLO or BARTON turbine meter.

CALIBRATION CORRECTION WITH METER FACTORS

During operation, the turbine meter may age and require recalibration. This can be achieved either with the changing of the K-factor or with a meter factor correction. Applying a meter factor preserves the K-factor calibration record that was captured when the meter was new and applies a multiplier acquired when the meter is flow tested during commissioning or post use. The magnitude of a meter factor can be a useful indicator of the health of the meter's internals.

The following examples explain the adaptability of this feature.

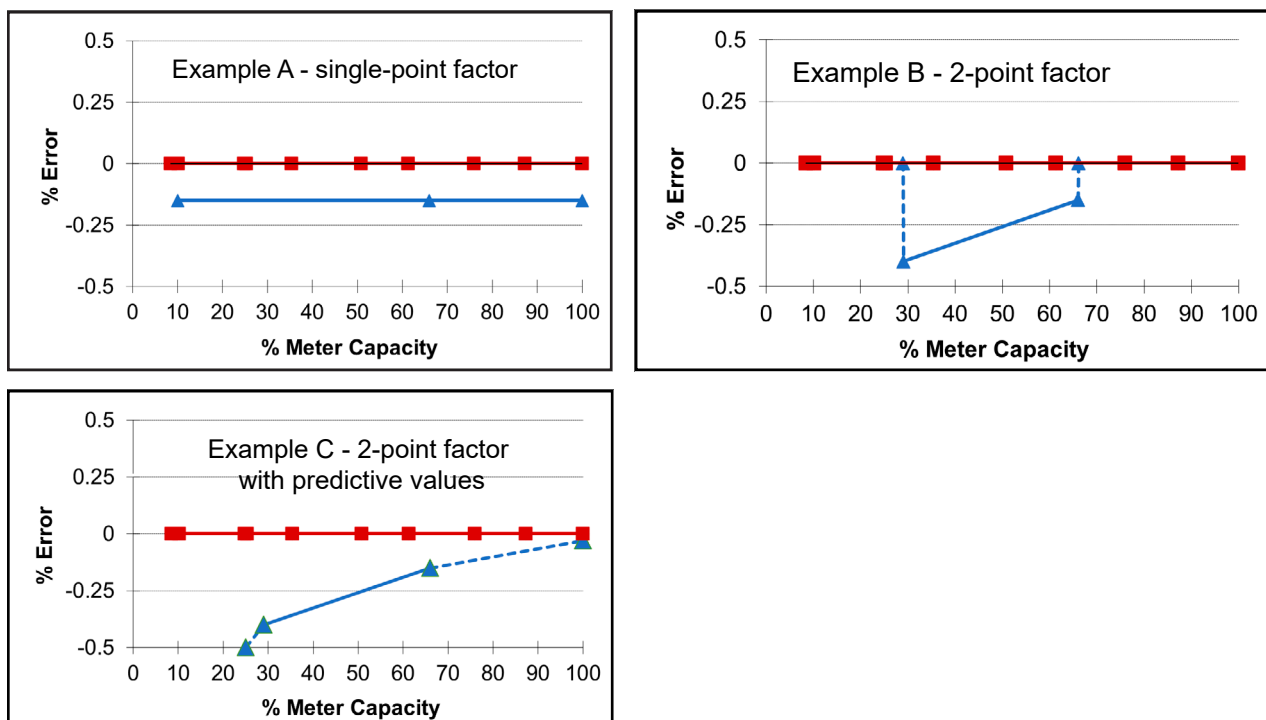

Figure 1.7—Calibration correction example

In Example A, a single flow rate is tested. The meter reads 0.15% low so the technician needs to bias the established linearized K-factor by 1.0015023 to restore error free measurement ($100\% - 0.15\% = 99.85\%$). The single meter factor menu choice simplifies this task.

In Example B, two flow rates are tested at normal flow rates. When two meter factors are entered, the MC Synergy linearly interpolates the meter factor and applies the computed meter factor to all readings within the flow range (for this example, 29% to 66%.) When flowing outside these flow rates, the meter factor for the last measurement point is applied.

In Example C, the same two flow rates are tested and corresponding meter factors are entered, but the operator adds predictive data points to reflect expected behavior beyond the tested data points. It is well known that viscosities significantly greater than that of water affect both the low flow capacity and linearity of a turbine meter. Adding predictive datapoints based on operator experience can provide a more realistic metering result.

MULTIPLE POWER SUPPLY OPTIONS

The MC Synergy EXP Totalizer can be powered by one or two lithium batteries, or an alkaline battery pack. Battery status is monitored by an integrated system and displayed on the LCD. Low-power microprocessor technology enables the totalizer to operate approximately 2 years on a single lithium battery.

Alternately, the totalizer may be powered by an external power source (an external power supply or an externally powered expansion board). When external power is supplied, the lithium battery or alkaline battery pack provides a backup power supply, significantly extending battery service life. Wiring diagrams for connecting an external power supply are provided in [External Power Supply, page 40](#).

GAS VOLUME CORRECTION

Gas turbine meters are calibrated in actual cubic feet (ACF), and measure gas in actual cubic feet. In some applications, you may benefit from referencing gas measurements back to standard conditions by measuring in terms of standard cubic feet (SCF).

Example: Gas Measurement Using a Calculated Divisor

This example shows how to calculate the divisor for gas measurement for use with the MC Synergy. The divisor in this example is pulse per cubic foot. The conversion factor (CON) is 1.00.

Calibration Information

- A NuFlo 2-in. high-range gas turbine meter will be used to measure gas flow with an average flowing pressure of 120 PSIG and an average flowing temperature of 50°F.
- The meter factor is 72.56 pulses per actual cubic foot (PACF).
- The unit of measure for volume is to be cubic meters.
- The unit of measure for the flow rate is to be cubic meters per day.
- The standard conditions to compensate are 60°F and 14.73 PSIA.
- The atmospheric pressure is unknown, but the elevation is 1,000 feet above sea level.

Calibration Procedure

1. Calculate the divisor and divisor decimal point position using the following equation:

$$\text{Divisor} = \frac{FC * Ps * Tf * CON}{(Pg + Pa) * Ts * (Fpv)^2}$$

where:

FC = Meter calibration factor in pulses per actual cubic foot (PACF)

Ps = Standard pressure in PSIA

Tf = Average flowing temperature in degrees Rankine (°R)

CON = Conversion factor for number of standard cubic feet (SCF) per unit volume of desired measure

Pg = Average flowing pressure in PSIG

Pa = Atmospheric pressure in PSIA

Ts = Standard temperature in degrees Rankine (°R)

Fpv = Supercompressibility factor (enter a factor of 1 if the supercompressibility factor is not known)

2. Determine the super compressibility factor. In this example, Fpv = 1.0102.
3. Determine the average atmospheric pressure at 1000 feet above sea level (14.21 PSIA). Pa = 14.21 PSIA.

4. Determine the factor for converting Fahrenheit to Rankine ($^{\circ}\text{R} = ^{\circ}\text{F} + 459.67$).
 - a. Flowing Temperature (T_f) = $50\text{ F} + 459.67 = 509.67^{\circ}\text{R}$
 - b. Standard Temperature (T_s) = $60\text{ F} + 459.67 = 519.67^{\circ}\text{R}$
5. The divisor being used under MC Synergy is pulse per cubic foot, the Conversion Factor CON is 1.00.
6. Substitute calculated values for variables in the formula to obtain the divisor.

$$\text{Divisor} = \frac{FC * Ps * Tf * CON}{(Pg + Pa) * Ts * (Fpv)^2} = \frac{72.56 * 14.73 * 509.67 * 1.00}{(120 + 14.21) * 519.67 * (1.0102)^2} = 7.6535$$

7. Ensure the K-Factor unit in the MC Synergy is configured as pulse per cubic foot (CF). In this example, K-Factor = 7.6535.

Note All cubic foot measurements are indicated in the LCD as CF regardless of whether the value is entered as actual cubic feet or calculated as standard cubic feet. There is no unique indicator on the LCD for standard cubic feet.

PROGRAMMABLE INPUT SIGNAL OPTIONS

The flowmeter signal can be obtained from a magnetic pickup or a pre-amplifier device. The sensitivity of the flowmeter input may be adjusted with the keypad, PC software, or Digital Data Plate application. See [Input Wiring, page 42](#) for wiring diagrams. See [Configure Input Type, Sensitivity and Meter Kit Alarm, page 70](#) for configuration procedures.

MULTIPLE OUTPUT OPTIONS

The MC Synergy EXP Totalizer standard circuitry provides:

- Two digital outputs, each configurable as one of the following output types:
 - A status (alarm) output which can OR/AND alarms together
 - A scaled pulse output (representing an increment in volume for each pulse)
 - A precision pulse output (MC-III compatible)
 - An amplified raw flowmeter frequency output (for use with remote equipment to derive flow rate and volume)
 - Modbus control via register writes
- Two RS-485 outputs for communication with PC software or other telemetry equipment

Optional expansion boards offer these additional outputs:

- Analog/HART output when a 4-20 mA/HART expansion board is installed. When the 4-20 mA rate output feature is used, the MC Synergy EXP Totalizer is powered by the current loop, and the lithium battery or alkaline battery pack is used as a backup supply.
- Modbus TCP or Modbus Over TCP protocol using IEEE 802.3 when an Ethernet expansion board is installed

The pulse output feature should be turned off when not required for reduced current consumption, especially when powering the device with internal batteries.

See [Output Wiring, page 44](#) for wiring diagrams. See [Section 3: Device Configuration via the Keypad, page 53](#) for configuration procedures.

ALARMS

The MC Synergy supports a variety of turbine alarms, system alarms, and eight user-defined alarms.

Acknowledging Alarms

Press the MENU button to access the Acknowledge Alarms control from the keypad. See [Acknowledge Active Alarms, page 55](#) for details. Alarms can be acknowledged (cleared) from the keypad, PC software, or Digital Data Plate app. If alarm conditions persist after an active alarm is acknowledged, the alarm will be re-activated.

Status Alerts and Alarm Messages

When a turbine flow alarm or user-defined alarm is triggered, the alarm is displayed on the LCD as follows:

- When an alarm condition is detected, a two-digit status alert will appear on the display (“Lo” for low flow, in).
- The top and bottom rows of the LCD will display an alarm message as shown below or a combination of an alarm value (top) and an alarm label or type (bottom).



Figure 1.8—Turbine flow alarm display

The persistence of the status alert and alarm message will vary, depending on the type of alarm and whether the alarm is acknowledged.

- | | |
|---|--|
| <p>When a turbine flow alarm condition is detected</p> | <ul style="list-style-type: none"> • The top row of the LCD displays the message “Active.” • The bottom row displays the alarm type (Low Flow or High Flow). • A two-digit status alert such as “LL” for low-low flow, appears in the left half of the display. Indicators are supported for low-low alarms, low alarms, high alarms, and high-high alarms. |
| <p>When the alarm condition clears and the alarm is acknowledged</p> | <ul style="list-style-type: none"> • All alarm indicators disappear and the display is restored to normal readout. |
| <p>When the alarm condition clears but the alarm is not acknowledged</p> | <ul style="list-style-type: none"> • The top row of the LCD displays the message “Inactive.” • The bottom row displays the alarm type (Low Flow or High Flow) that was triggered until the alarm is acknowledged. • A two-digit status alert such as “LL” for low-low flow appears in the left half of the display until the alarm is acknowledged. |

When an **unacknowledged alarm** condition changes but does not clear (for example, a Low-Low alarm changes to a Low alarm)

- The top row of the LCD continues to display the message “Active.”
- The bottom row continues to display the alarm type (Low Flow, for example).
- The two-digit status alert will display the original alarm condition status (LL in this example) until the original alarm is acknowledged. If the subsequent alarm condition remains active at that time, the two-digit status alert will reflect that current condition (Lo in this example).

Turbine Health Status Alerts and Alarm Messages

Unlike turbine flow alarms, turbine health alarms (bent blade, lost blade, or erratic signal) are triggered when a vulnerability is detected through a continuous health test and evaluation process. This necessitates a couple of key differences in the way status alerts and alarm messages behave.

- When a turbine health alarm condition is detected, a two-digit status alert will appear momentarily on the flow volume display (“Lb” for lost blade, in the example below), then disappear and reappear intermittently as the MC Synergy detects the condition in repeated health test cycles. Health test periods are user-configurable using PC software or the Digital Data Plate application.
- A persistent alarm message will also appear (Figure 1.9). The message will clear upon acknowledgement but reappear with each new health test period for as long as the alarm condition is active.



Figure 1.9—A turbine health alarm message (right) is preceded by a momentary two-digit status alert upon detection of a meter health vulnerability such as a missing or lost blade.

Note	The status alert (Lb, for example) displays intermittently, paced by a user-configurable health test period.
------	--

Hold-Off and Deadband

Alarm activation is delayed by a hold-off period value. If a measured value temporarily enters an alarm condition, the alarm condition must persist longer than the designated hold-off period to be considered an active alarm.

An alarm will deactivate only after the alarm parameter value drops by the deadband value below the alarm point for the assigned hold-off period. This helps ensure that an alarm does not deactivate until the value triggering the alarm is within a safe range.

Digital Outputs

You can configure a digital output to perform a function, such as turning on a light or activating a sound, when conditions trigger an alarm. PC software settings allow you to configure alarm preferences such as alarm

latching, output state definitions, and logging of triggered alarms in an archive record. See the Software User Manual for details. See also [Event and Alarm Log Archival, page 28](#).

Turbine Alarms

Turbine alarms provide diagnostic information on the health of the meter connected to an MC Synergy and the meter’s flowing conditions. See [Table 1.3](#) for a complete list of turbine alarms.

Zero-flow conditions at startup will not trigger an alarm. However, once flow is established, a low-flow alarm will remain active for as long as the low flow condition is present, even if it reaches a zero-flow state.

TABLE 1.3—TURBINE ALARMS DETAIL

Status Alert	Alarm Message	Alarm Type	Definition	Hold-off Period	Deadband
		Low-Low Flow	Meter Min Flow Range / 2	2 min	0.01% of meter range
		Low Flow	Meter Min Flow Range	2 min	0.01% of meter range
		High Flow	Meter Max Flow Range	2 min	0.01% of meter range
		High-High Flow	Meter Max Flow Range + 20% (Meter Max Flow Range - Meter Min Flow Range)	2 min	0.01% of meter range
		K-Factor Invalid The LCD will display this message until the error is resolved.	The entered K-Factor calibration is invalid.	None	N/A
			Factor minimum value is 0.0001		
			Factor maximum value is 1E9		
			Multipoint frequency minimum value is 0.0000		
			Multipoint frequency maximum value is 1E4		
			Multipoint minimum number of factor is 2		
		Multipoint maximum number of factor is 12			
		Unstable Flow	Fluctuations > 10 seconds in the flow rate observed over an extended period.	10 sec	N/A

TABLE 1.3—TURBINE ALARMS DETAIL

Status Alert	Alarm Message	Alarm Type	Definition	Hold-off Period	Deadband
		Meter Factor Invalid The LCD will display this message until the error is resolved.	The entered Meter Factor calibration is invalid. The range of valid values is the same as the range of valid K-Factor values.	None	N/A
		Bent Blade	> 2° deflection from the turbine input signal	user-defined health test period ¹	0.1 degree
		Lost (Missing) Blade	Blade is severely bent, washed out, or suspected to be broken off/missing	user-defined health test period ¹	N/A
		Erratic Signal	Signal appears to be intermittent, noisy, or outside of expected parameters	user-defined health test period ¹	N/A
		Replacement Kit	The cumulative days of turbine kit service equals the configured meter replacement period.	1 sec	0.3 days

1. The user-defined health test period is configured in PC software or the Digital Data Plate application. In PC software, select the gray Configure Device menu tab and choose the Turbine Input tile.

System Alarms

System alarms provide status of system parameter including power supply voltages. See [Table 1.4](#) for the complete list of System Alarms.

System alarms trigger when either the time has not been synced, or if the device is at risk of losing power. When the alarm condition has been serviced (i.e. battery has been replaced to address a low battery warning), acknowledge the alarm to reset the status.

TABLE 1.4—SYSTEM ALARMS

Status Alert	Alarm Message	Alarm Type	Definition	Hold-off Period	Deadband
		Time Not Set	The clock battery has expired and the device has lost power, or the time has not been set.	None	N/A
	No message is displayed by default. Create a user-defined alarm if desired.	Supply Voltage	High-High alarm: 33 VDC High alarm: 27 VDC Low alarm: 6 VDC Low-Low alarm: 5 VDC	5 sec	0.7 VDC
	No message is displayed by default. Create a user-defined alarm if desired.	Expansion Voltage	High-High alarm: 18 VDC High alarm: 16 VDC Low alarm: 4 VDC Low-Low alarm: 3.5 VDC	5 sec	0.7 VDC
		BAT1/ BAT2 Voltage (Lithium Battery only) The LCD will display this message until the error is resolved.	High-High alarm: 6.0 VDC High alarm: 5.0 VDC	5 sec	0.2 VDC
		BAT1/ BAT2 Percent (Lithium Battery only) Use with new batteries only.	Battery Low alarm: 20% battery life remains Battery Low-Low alarm: 10% battery life remains	10 sec	1%

User-Defined Alarms

User-defined alarms ([Table 1.5, page 27](#)) provide status of selected conditions in the system. You can create up to eight custom alarms using the PC software. Custom alarms provide the flexibility to alarm on a wide range of conditions. For example, you can create an alarm based on a user-specified flow range instead of the meter flow range.

User-defined alarms can trigger on a high setpoint, a low setpoint, or on both a high and a low setpoint. You can establish a two-level alarm by assigning a high/low alarm and a high-high/low-low alarm to the same register. Each alarm has a user-configurable deadband and hold-off period.

Each alarm can only be assigned to one register at a time. Therefore, if a two-level alarm is desired, two alarms must be entered for the same register—one to assign a high/low alarm, and one to assign a high-high/low-low alarm.

TABLE 1.5—USER-DEFINED ALARMS DETAIL

Status Alert	Alarm Message	Alarm Type	Hold-off Period	Deadband
LL		User-Defined Low-Low	User-Defined	User-Defined
Lo		User-Defined Low	User-Defined	User-Defined
hI		User-Defined High	User-Defined	User-Defined
hh		User-Defined High-High	User-Defined	User-Defined
Lo or hI		User-Defined High/Low	User-Defined	User-Defined
LL or hh		User-Defined High-High/ Low-Low	User-Defined	User-Defined
uA		User-Defined Unacknowledged Alarm	N/A	N/A

FLOW LOG ARCHIVAL

The MC Synergy EXP Totalizer saves up to 384 daily logs and 768 interval logs in nonvolatile memory. Daily logs are created at the end of the contract day as defined by the Contract Hour. Interval logs are created at user-defined intervals ranging from 1 minute to 12 hours (default: 1 hour). Archive contents such as volume, run-time, system voltages, etc. are user-configurable with the PC software.

Flow archives can be retrieved using the PC software or with an Enron poller. By connecting with PC software, you can download the logs for viewing a grid or trend chart. Log data can also be printed or exported. All data reporting is supported by Sensia's ScanData software.

EVENT AND ALARM LOG ARCHIVAL

The MC Synergy EXP Totalizer saves up to 768 event and 768 alarm logs. Event logs are generated to track user changes such as K-factor changes, input setting changes, power-on reset and “watch-dog” reset, flow cut-off and frequency cutoff.

There are 3 alarm classifications:

- turbine alarms: turbine health, above/below flow rate range, kit replacement, K-factor, meter factor error
- system alarms: clock not set, system voltages/health
- user-defined alarms (qty 8)

Alarm logs are user-defined logs that track when a selected parameter in the register table goes above or below an acceptable value, or outside of a pre-defined window. By connecting with the PC software, you can download the logs for viewing and/or printing in tabular format. In addition to showing old and new values, each log is time-stamped and includes the register associated with the change.

PASSWORD-PROTECTED SECURITY

A configuration security access code prevents unauthorized personnel from altering the calibration or accumulated volume data in the instrument. The security feature may be disabled if this protection is not required. Password-protected security access is enabled via the PC software. When this feature is enabled, you will be prompted for a password when attempting to enter any menu from the keypad.

OPTIONAL FEATURES

EXPLOSION-PROOF COMMUNICATIONS ADAPTER

An explosion-proof communications adapter provides an RS-485 connection for connecting a laptop or PC to the instrument without removing the instrument cover. When the adapter is ordered with an MC Synergy EXP Totalizer, it is factory installed. It may be relocated to either conduit opening in the instrument housing. When ordered separately, the adapter is easily installed using the instructions provided in [Appendix A—Hardware Options, page A-1](#).

RS-485 IS BARRIER

The MC Synergy EXP Totalizer's RS-485 output is approved for intrinsically safe installations for use in CEC/NEC Division areas only. An intrinsically safe barrier assembly with a conduit seal enables the RS-485 output to be used as an intrinsically safe output. In such installations, only the turbine flowmeter input may be used. See [Figure 2.23, page 50](#) for an IS barrier assembly wiring diagram.

ANALOG OUTPUT AND HART COMMUNICATION VIA EXPANSION BOARD

An Analog Output/HART expansion board may be plugged into the main board to allow analog output and communication with other devices via the HART communication protocol, through point-to-point or multi-drop configuration.

When an expansion board is purchased with an MC Synergy totalizer, the expansion board is pre-installed at the factory before shipment. If it is purchased separately, please see [Installing an Expansion Board, page A-7](#).

For wiring instructions, see [Analog Output and HART Communication via Expansion Board, page 28](#) and [Figure 2.17, page 47](#), [Figure 2.18, page 47](#), and [Figure 2.19, page 48](#).

ETHERNET COMMUNICATION VIA EXPANSION BOARD

An Ethernet expansion board may be plugged into the main board to allow communication with the MC Synergy via an Ethernet connection. This may be run through a cabled connection or through a router.

When an expansion board is purchased with an MC Synergy totalizer, the expansion board is pre-installed at the factory before shipment. If it is purchased separately, please see [Installing an Expansion Board, page A-7](#).

For wiring instructions, see [Ethernet Power \(Ethernet Expansion Board\), page 40](#), and [Ethernet Communication \(Expansion Board Required\), page 48](#).

COMMONLY USED FUNCTIONS

While the functions of the MC Synergy EXP Totalizer are too numerous to mention, some of the most commonly used functions are detailed in this section. They include:

- Reading the rate and accumulated total
- Saving totals to memory
- Resetting the total

READING TOTALS

Accumulations can be viewed from the LCD on the front of the MC Synergy EXP Totalizer. The grand total, current day, previous day, current interval, previous interval, current month, and previous month are all available for viewing on the display. The MC Synergy calculates the accumulations every 4 seconds by default. You can adjust the calculation/sampling period with the PC software or the Digital Data Plate application.

SAVING TOTALS TO MEMORY

Volume accumulations are automatically saved to non-volatile memory. In the event of a power failure, the last saved accumulations will be restored when power is restored.

RESETTING THE TOTAL

Totals can be reset to zero using the keypad, the PC software, the Digital Data Plate app, an optional reset switch, or a pulse from an external device.

- To reset the total using the keypad, press MENU and use the INC button go to the Clear Totals menu. Press ENTER to confirm.
- To reset the total with an external pulse generator located in safe area, configure the pulse to be active for at least 3 seconds.
- To reset the total using the Digital Data Plate app, navigate to the Maintenance menu and click the device command Reset Grand Total.

TABLE 1.6—FEATURE ACCESS OPTIONS

	DDP App	PC or Modbus	Device Keypad	HART
Device Status				
View Real Time Data	✓	✓	✓	✓
View System Information	✓	✓	✓	✓
View Live Alarm Status		✓	✓	✓
View Archive Status	✓	✓		
Device Setup/ Identification				
Configure Device ID and Location Data	✓	✓		✓
Configure Measurement Units (Total, Rate, Range and K-Factor)	✓	✓	✓	Partial (K-Factor Unit)
Communications (Serial Port)				
Config Comm Parameters	✓	✓	✓	
Communications (Ethernet Port)				
Configure Full Network	✓	✓		N/A
Set IP Address Mode (Static/DHCP)	✓	✓	✓	N/A
Device Interface Setup				
Configure Display Mode	✓	✓	✓	
Select Display Items	✓	✓	✓	
Change Display Unit	✓	✓	✓	Override to HART Unit
Manage Keypad Security	✓	✓	✓	
Configure Reset Input	✓	✓		
Bluetooth				
Configure Bluetooth		✓	✓	
Reset Bluetooth			✓	
Archives				
Configure Archive (Contract Hour, Period, Items)		✓		
Download		✓		
Alarms				
Acknowledge Alarms	✓	✓	✓	
Setup User Defined Alarms		✓		
Meter Input				
Sample Period	✓	✓		✓
Meter Sensitivity	✓	✓	✓	✓

TABLE 1.6—FEATURE ACCESS OPTIONS

	DDP App	PC or Modbus	Device Keypad	HART
Configure Turbine Health Diagnostics	✓	✓		
Meter Calibration Entry				
Validate/ Revise Meter Data	✓	✓		✓
Set Meter Range	✓	✓		✓
K-Factor Settings	Linear Only	✓	✓	✓
Meter Factor Settings	Linear Only	✓	✓	✓
Set Meter Kit Life	✓	✓		
Upload Meter and Calibration Data	✓			
Analog Output/ HART				
Configure HART Settings and Values	✓	✓	✓	✓
Configure Zero/ Full Scale Values	✓	✓	✓	✓
Test Output / Simulate Flow Rate	✓	✓		✓
Digital Outputs				
Change Mode (Precision Pulse, Scaled, Status, Amplified Raw, Modbus)	✓ (see note 1)	✓	✓ (see note 1)	
Change Scaled Pulse Output	✓	✓	✓	
Configure Alarm Links		✓		
Change Output Default State (NO, NC)	✓	✓		
Change Latching State (Latching, Non-Latching)		✓		
Maintenance				
Export, Load, Restore Config using SRF File		✓		
Set / Sync Time	✓	✓	✓	✓
Reset Grand Total	✓	✓	✓	✓
Create Partial Record		✓	Reset Switch	
Reset Port Stats		✓		
Load Defaults		Configuration, Comms, and Calibration Defaults	Configuration Defaults Only	
Upgrade Firmware/ Activate Stored Firmware		✓		
Reset Meter Kit Life		✓	✓	
Calibrate/ Reset Analog Output		✓		✓
Publish Polling Total (Batch)		Via Modbus	Reset Switch	✓

Note 1: When Status or Modbus is selected, configuration must be performed with PC software.

Page intentionally left blank

Section 2: Installation

The MC Synergy™ EXP Totalizer is fully assembled at the time of shipment and ready for mounting to a flowmeter. The MC Synergy is shipped with 3/4" recessed pipe plugs installed facing right and left, and the pipe union facing downward (Figure 2.1). If the device is equipped with an explosion-proof reset switch, only one plug is required. The switch may be installed in the right or left conduit opening.



WARNING

To prevent ignition of hazardous atmospheres, do not remove the cover while circuits are alive. **DO NOT OPEN WHEN AN EXPLOSIVE GAS ATMOSPHERE IS PRESENT.** Under normal conditions, the MC Synergy EXP Totalizer poses no hazard when opened in a safe area.

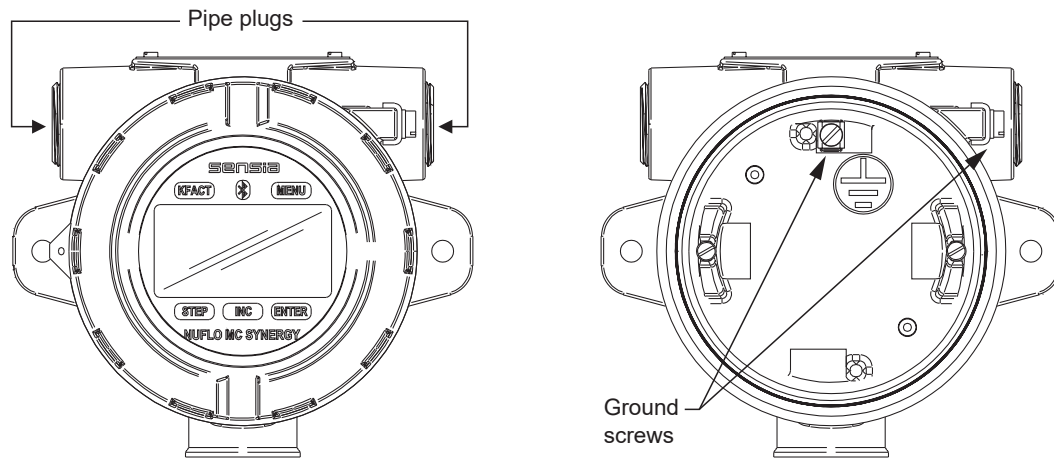

Figure 2.1—Enclosure entry and ground screw locations

Installation requirements and meter mounts vary with certification regulations and meter types. For ATEX/IECEx installation requirements, see [Hazardous Area Installations \(ATEX/IECEx\)](#) below. For CEC/NEC installation requirements, see [Hazardous Area Installations \(CEC/NEC\)](#), page 37.

If the instrument is to be installed in a hazardous area, Sensia recommends that you configure the device prior to mounting or via intrinsically safe remote communication using the PC software. However, the keypad may be navigated through the glass without removing the lid.



WARNING

Once the instrument is mounted in a hazardous area, the cover should not be removed unless the area is void of combustible gas and vapors.

HAZARDOUS AREA INSTALLATIONS (ATEX/IECEX)

The ATEX-certified MC Synergy EXP is fully compliant with European ATEX Directive 2014/34/EU, Annex II, 1.0.6 and have been evaluated to the following standards:

- IECEX: IEC 60079-0, IEC 60079-1, IEC 60079-31
- ATEX: EN IEC 60079-0, EN 60079-1, EN 60079-31

The following instructions apply to equipment covered by certificate numbers ATEX CSANe 21ATEX1250X and IECEX CSAE 21.0032X:

- The device may be used in the presence of flammable gases and vapours with apparatus groups IIA, IIB+H2 and IIC and with temperature classes T1, T2, T3, T4, T5, and T6.
- The device is certified for use in ambient temperatures in the range -40°C to 70°C and should not be used outside this range.
- The device has not been assessed as a safety-related device (as referred to by Directive 2014/34/EU, Annex II, clause 1.5).
- Installation shall be carried out by suitably trained personnel in accordance with the applicable code of practice (EN 60079-14 within Europe).
- Repair of this equipment shall be carried out by Sensia or in accordance with the instructions in this manual.
- If the instrument is likely to come into contact with aggressive substances, you are responsible for taking suitable precautions to prevent it from being adversely affected, thus ensuring that the type of protection is not compromised.
 - Aggressive substances may include, but are not limited to, acidic liquids or gases that may attack metals, or solvents that may affect polymeric materials.
 - Suitable precautions may include, but are not limited to, regular checks as part of routine inspections or establishing from the material's data sheet that it is resistant to specific chemicals.

CONDITIONS FOR SAFE USE (ATEX/IECEX)

- The product may be fitted with a communication adaptor. When removing the conduit plug to fit the data transfer socket to the communication adaptor and during data transfer, the user/installer shall ensure that no explosive atmosphere is present. After data transfer has finished, the conduit plug shall be re-fitted in accordance with the relevant Code of Practice.
- When the standoff tube is fitted, it shall be used with turbine meter pick off coil bosses in accordance to those listed in certificate Sira 03ATEX1474U.
- Some external parts of products that have epoxy powder-coated aluminum housing are non-conducting and may generate an ignition-capable level of electrostatic charges under certain extreme conditions. The user should ensure that the equipment is not installed in a location where it may be subjected to external conditions (such as high-pressure steam) which might cause a build-up of electrostatic charges on non-conducting surfaces. Additionally, cleaning of the equipment should be done with a damp cloth.
- Repairs of flameproof joints or dust ignition protection joints are not permitted. If any joint is damaged please contact manufacturer.
- Under rated conditions, the branching point at the entry point may reach 80°C, therefore, when choosing cables and cable glands this shall be taken into account.
- Replace the lithium battery only with the ATEX/IECEX approved battery supplied by Sensia (Part No. 9A-100005111).
- The lithium battery that powers the MC Synergy EXP is a sealed unit; however, should a lithium battery develop a leak, toxic fumes could escape upon opening the enclosure. Ensure that the instrument is in a

well-ventilated area before opening the enclosure to avoid breathing fumes trapped inside the enclosure. Exercise caution in handling and disposing of spent or damaged batteries.

MOUNTING OPTIONS (ATEX/IECEX)

The ATEX-approved MC Synergy EXP may be mounted directly to a flowmeter, or mounted remotely on a pole and connected to a flowmeter with explosion-proof signal cable. The type of meter mount required varies with the meter in use. See Figures 2.2 through 2.4 for installation dimensions.

- Mount the device to a NUFLO turbine meter. A 3/4-in. to 1-in. standoff tube is required (Figure 2.2).
- Mount the device to a BARTON 7000 Series turbine meter. A 3/4-in. to 3/4-in. stainless steel standoff tube is required (Figure 2.3, page 36). (The 3/4-in. to 1-in. reducer supplied with the BARTON 7000 Series meter is not required when the standoff tube is used.)
- Mount the device to a flat, vertical surface.
- Remote-mount the device to a 2-in. pole using a NUFLO hardware kit (Figure 2.4, page 36). Pole mounting may be preferred where limited space or pipe vibration prohibits direct-mount installation. For best results, install the device as near as possible to the meter to minimize the length of explosion-proof signal cable that must be used for communications. Stranded, shielded cable is recommended.

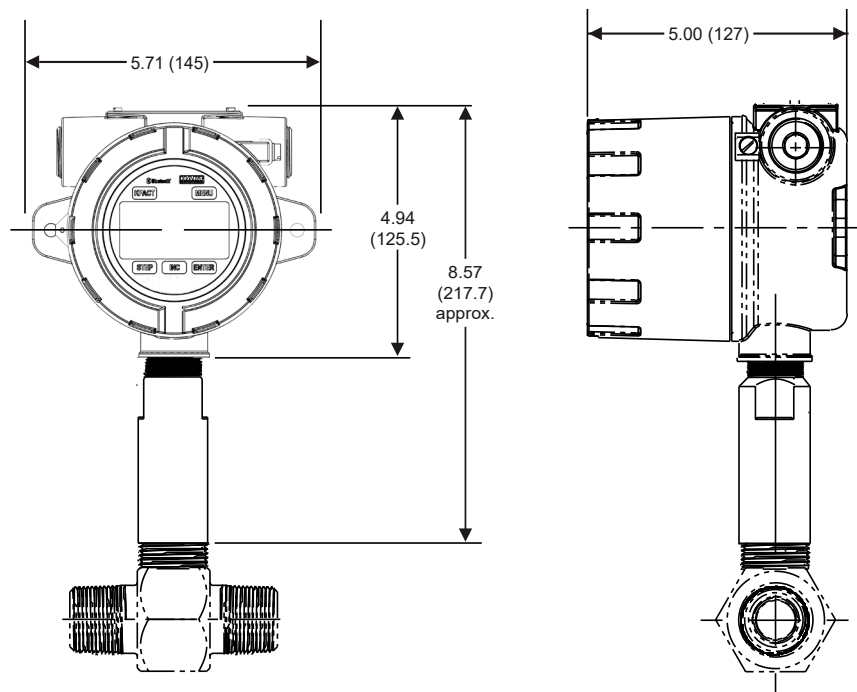

Figure 2.2—Direct mount to NUFLO turbine meter with 3/4-in. to 1-in. standoff tube (ATEX)

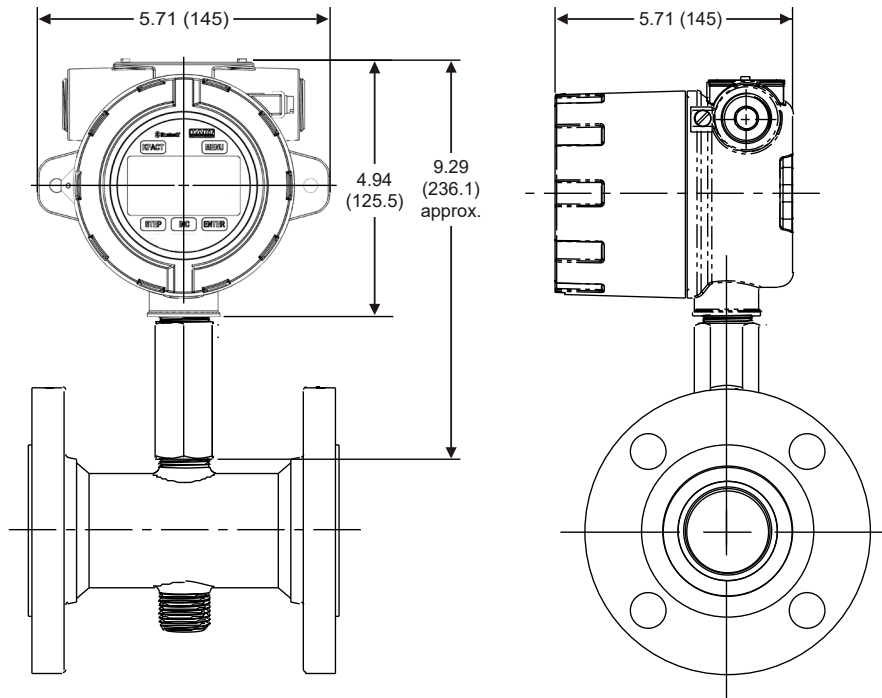

Figure 2.3—Direct mount to a BARTON 7000 series flowmeter with 3/4-in. to 3/4-in. standoff tube (ATEX)

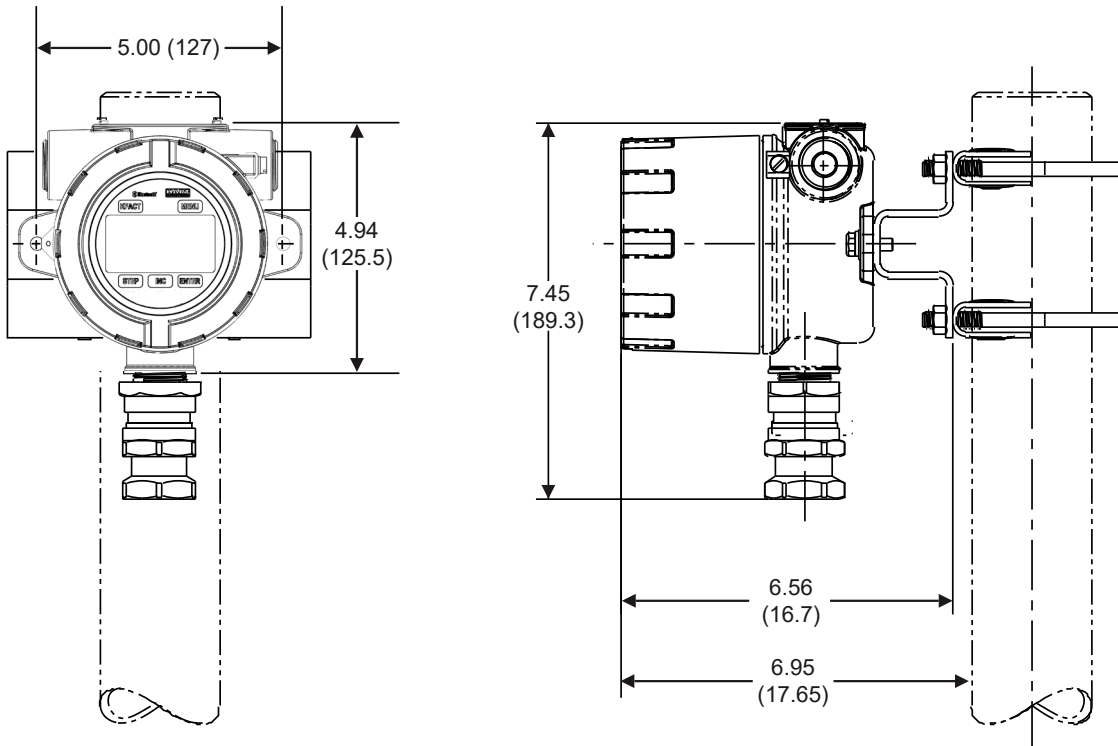

Figure 2.4—Remote mount on a 2-in. pole using a NUFLO hardware kit (Part No. 9A-30028004)

HAZARDOUS AREA INSTALLATIONS (CEC/NEC)

The CSA-approved MC Synergy EXP is certified as explosion proof for Class I, Division 1, Groups B, C, and D for use in the US and Canada.

CONDITIONS FOR SAFE USE (CEC/NEC)

- All cable and cable glands must be rated for 80°C.
- The device may be used in the presence of flammable gases and vapours with apparatus groups B, C, and D and with temperature classes T1, T2, T3, T4, T5, and T6.
- The device is certified for use in ambient temperatures in the range -40°C to 70°C and should not be used outside this range.
- Do not remove the cover unless the area is void of combustible gas and vapors.
- Before removing the pipe plug to install a communications adapter, or disassembling the union nut and blanking plug in a pre-installed communications adapter, make sure the area is nonhazardous. Reinstall the pipe plug in accordance with the instructions in this manual.
- All field wiring must conform to the National Electrical Code, NFPA 70, Article 501-4(b) for installations within the United States or the Canadian Electric Code for installations within Canada. State and local wiring ordinances may also apply. All field wiring must be rated for temperatures of 90°C or higher, use a copper conductor only, and have a wire range of 28 to 16 AWG. Terminal block screws must be tightened to a minimum torque of 5 to 7 in-lb. to secure the wiring within the terminal block. Only personnel who are experienced with field wiring should perform these procedures.
- Do not use Teflon® tape on threads of the union, reducer, or pipe plugs. Use of Teflon® tape will void the explosion-proof rating of the instrument. Replace the lithium battery only with the CSA-approved battery supplied by Sensia (Part No. 9A-100005111).
- Replace the optional alkaline battery pack only with the CSA-approved battery pack supplied by Sensia (Part No. 9A-50099002).
- The lithium battery that powers the MC Synergy EXP is a sealed unit; however, should a lithium battery develop a leak, toxic fumes could escape upon opening the enclosure. Ensure that the instrument is in a well-ventilated area before opening the enclosure to avoid breathing fumes trapped inside the enclosure. Exercise caution in handling and disposing of spent or damaged batteries.
- The MC Synergy EXP may be mounted directly to a flowmeter, or mounted remotely on a pole and connected to a flowmeter with explosion-proof signal cable. The type of meter mount required varies with the meter in use. See [Figure 2.5, page 38](#) and [Figure 2.6, page 38](#) for installation dimensions.
- Mount the device to a NUFLO turbine meter or a BARTON 7000 Series turbine meter. A CSA-approved pipe reducer and union connector is required ([Figure 2.5, page 38](#)). Union must be wrench tight.
- If mounting to the BARTON 7000 Series meter, a 3/4-in. to 1-in. reducer supplied with the meter is used to achieve the 3/4-in. connection required to mate the union to the meter.
- Mount the device to a flat, vertical surface. The standard enclosure is ideal for a bulkhead mount; the alternate enclosure is not recommended for bulkhead mounting.
- Remote-mount the device to a 2-in. pole using a NUFLO hardware kit ([Figure 2.6, page 38](#)). Pole mounting may be preferred where limited space or pipe vibration prohibits direct-mount installation. For best results, install the device as near as possible to the meter to minimize the length of explosion-proof signal cable that must be used for communications. Stranded, shielded cable is recommended.

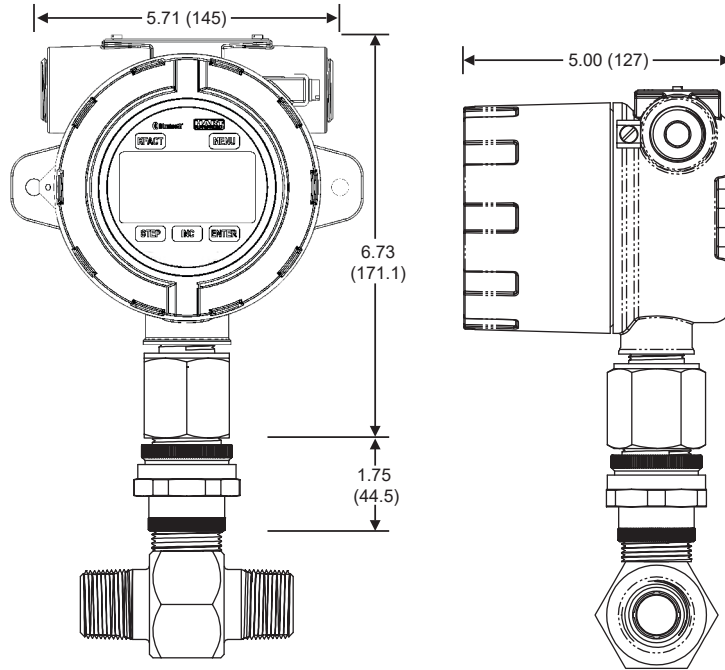

Figure 2.5—Direct mount (standard MC Synergy EXP enclosure) to NUFLO turbine meter with pipe reducer and union (CEC/NEC compliant)

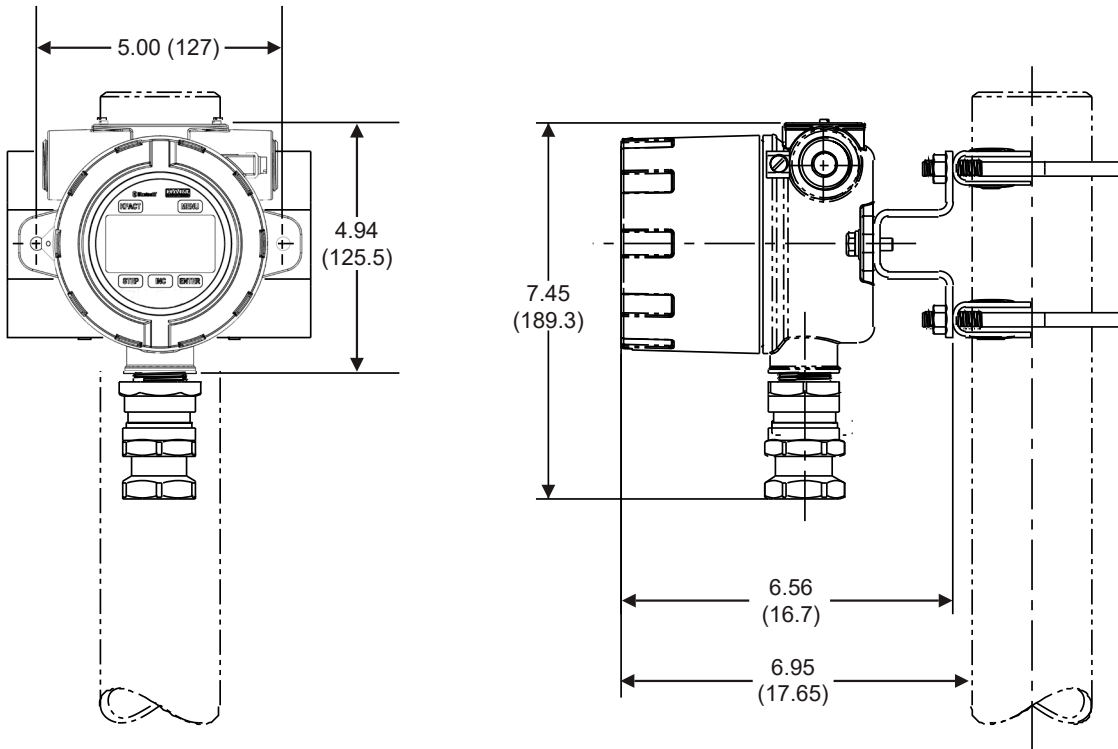

Figure 2.6—Remote mount on a 2-in. pole using a NUFLO hardware kit (Part No. 9A-30028004)

INSTALLING THE MC SYNERGY EXP

If the device is to be installed in a hazardous area, then configure the device prior to mounting it.

Install the MC Synergy EXP as follows:

1. Make sure the flowmeter and magnetic pickup are properly installed as follows:
 - a. Install the turbine flowmeter in the flow line.
 - b. Lightly grease the threads on both ends of the magnetic pickup, taking care to keep grease off of the connector contacts. If the connector is plastic, grease only the end that threads into the meter.
 - c. Install the magnetic pickup in the flowmeter.
2. Position the MC Synergy EXP above the flowmeter. If installing an ATEX-approved MC Synergy EXP with a tube adapter, make sure the signal cable is disconnected from the MC Synergy circuit board. This will prevent the cable from being damaged from twisting when the tube adapter is threaded onto the meter in step 6.
3. Plug the MC Synergy EXP cable connector into the magnetic pickup and hand-tighten the knurled nut on the connector.
4. Screw the MC Synergy EXP onto the flowmeter threads surrounding the magnetic pickup with the display facing the desired direction.
5. Tighten all pipe connections.



CAUTION

Do not use Teflon® tape on threads of the union, reducer, or pipe plugs. Use of Teflon® tape will void the explosion-proof rating of the instrument.

FIELD WIRING

The MC Synergy EXP supports connections for the following: internal power (batteries), external power (external supply and loop power), turbine flowmeter input, pulse input, remote reset input, pulse output, 4 to 20 mA output, flowmeter frequency (amp & square) output, and RS-485 output.

Wiring diagrams for each connection are provided below.



CAUTION

CSA has certified the MC Synergy EXP for use in hazardous locations in North America. All field wiring must conform to wiring methods for explosion-proof installations as defined in the National Electric Code for installations within the United States or as specified in the Canadian Electric Code for installations within Canada. State and local wiring ordinances may also apply.

To wire the MC Synergy EXP for operation, complete the following field connections:

1. Unscrew the cover of the enclosure and remove it.
2. Using a small standard blade screwdriver, remove the two #4-40 × 7/8" screws located to the right and left side of the display.
3. Lift the display assembly from the enclosure, making sure the circuit assembly does not contact the enclosure.
4. Connect the lithium battery or alkaline battery pack to the connectors marked "BAT 1" and "BAT 2" near the top of the circuit assembly.
5. Connect wiring for external power, if appropriate. See [Figure 2.7, page 41](#).
6. Connect the flowmeter or pulse input wiring to terminal block TB4. See [Figure 2.12, page 43](#), and [Figure 2.13, page 43](#).
7. Connect wiring for output signals, if appropriate. See [Figure 2.15, page 45](#), through [Figure 2.22, page 49](#).

8. Place the circuit assembly over the standoffs and fasten with the two #4-40 × 7/8" screws, ensuring that all connector wiring is inside the enclosure and in no position where it may be damaged when the enclosure cover is replaced.
9. Recalibrate the MC Synergy EXP (if necessary).
10. If external and internal power supplies were removed, reset the clock to ensure that the time stamps in the log data are accurate. This can be done through the PC software or keypad.
11. Replace the enclosure cover.

POWER SUPPLY OPTIONS

You can power the instrument from an external power supply connected to the main board, to the optional Ethernet expansion board, or to the optional Analog Out/HART expansion board to create a 4-20 mA current loop. Lithium or alkaline battery packs provide a backup power supply. The use of an external power source extends battery life and the backup battery packs help ensure that volume accumulation will not be interrupted during a power failure.

INTERNAL POWER SUPPLY

The MC Synergy EXP ships with a coin-cell battery for the real-time clock. Customers can choose any of three internal power supplies:

- One or two CEC/NEC-compliant 3.6V lithium batteries
- One or two ATEX/IECEX-compliant 3.6V lithium batteries
- A shrink-wrapped alkaline battery pack containing three C-size industrial-grade batteries (available only with CEC/NEC-compliant devices)

Low-power microprocessor technology enables the totalizer to operate approximately 2 years on a single lithium battery. The lithium battery is strongly recommended for use in temperatures below -20°C.

EXTERNAL POWER SUPPLY

The MC Synergy EXP can be connected to a remote power supply by a two-conductor cable ([Figure 2.7, page 41](#)). The power supply and cable must be capable of supplying 6 to 27 VDC @ 60 mA.

LOOP POWER (ANALOG OUTPUT/HART EXPANSION BOARD)

The MC Synergy EXP is available with an optional Analog Output/HART Board. The output is configured as a two-wire, isolated transmitter while providing loop power to the device. That is, it can be powered over the analog output ([Figure 2.8, page 41](#)) wiring on the expansion board. When the analog output is wired, it may provide an analog reading representing the flow rate. The loop power supply must be capable of sourcing a minimum of 12.5 to 27 VDC.

ETHERNET POWER (ETHERNET EXPANSION BOARD)

When wiring the optional Ethernet expansion board ([Figure 2.9, page 41](#)), connect external power to the expansion board. The expansion board will provide power to the main board. To read the voltage level of the external supply, connect the external power to the main board also.

Important Connect external power to the Ethernet Expansion Board when installed. Power must be supplied to the expansion board for Ethernet to function.

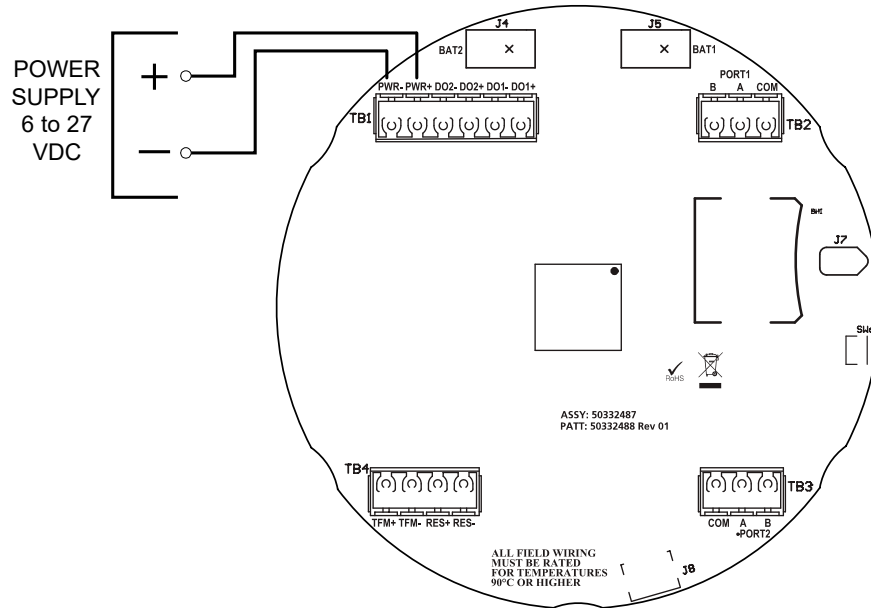

Figure 2.7—External power supply wiring

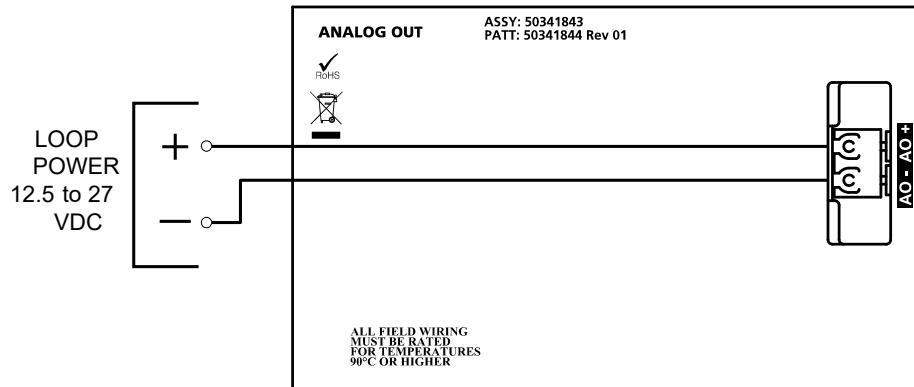

Figure 2.8—Loop power supply wiring

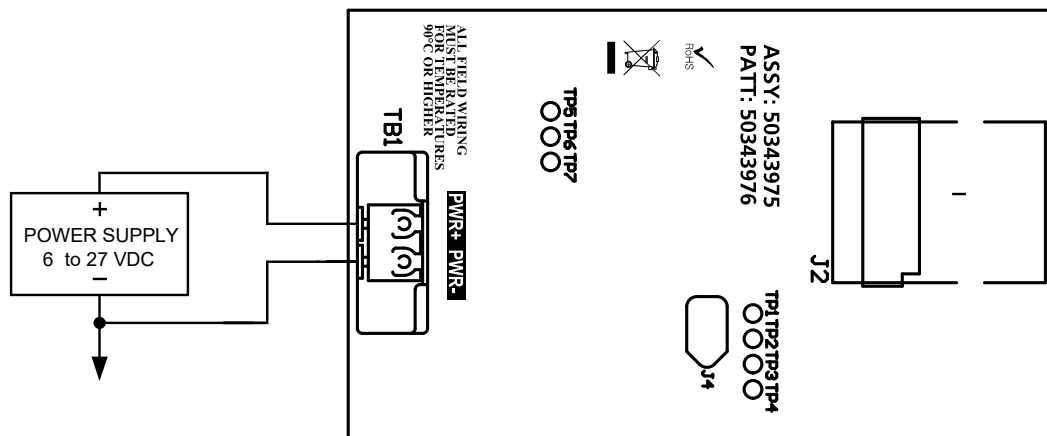

Figure 2.9—Ethernet expansion board wiring (move power cable from main board to expansion board)

INPUT WIRING

RESET INPUT

The remote reset input allows the operator to reset the accumulated volume on the MC Synergy EXP to zero without opening the enclosure. This input is not optically isolated. The input may be connected in one of two ways, either with a closed contact (switch) (Figure 2.10), or with a DC pulse in a remote location (Figure 2.11). The remote reset input mode (closed contact or DC pulse) is selectable through the PC software.

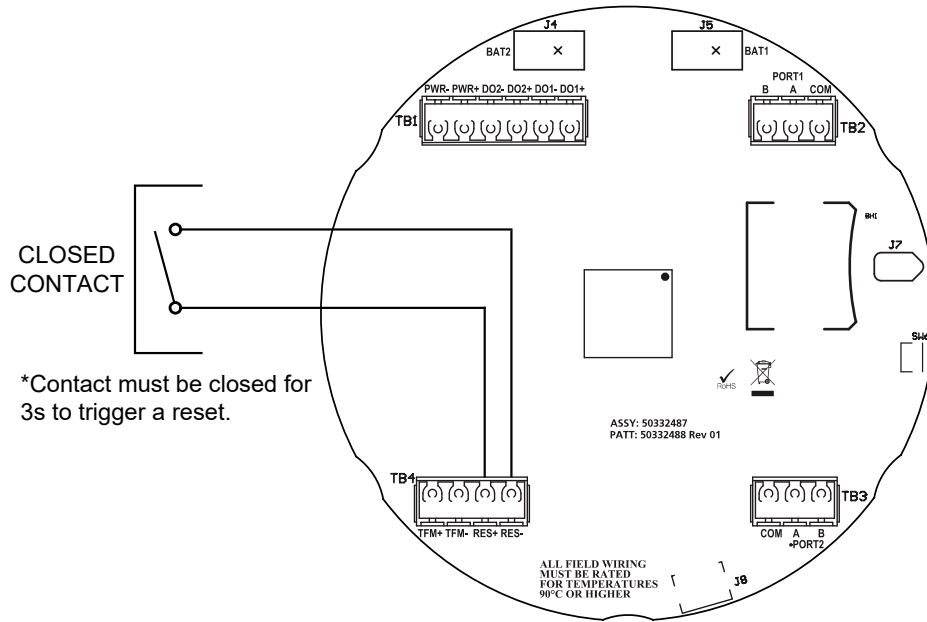

Figure 2.10—Reset wiring for contact closure

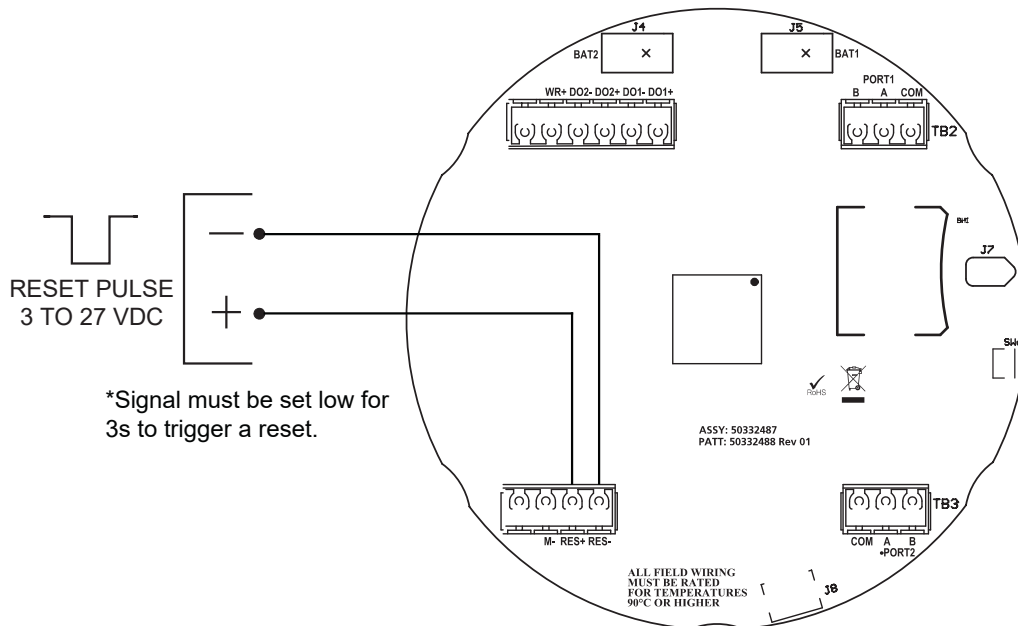

Figure 2.11—Reset wiring for pulse input

TURBINE FLOWMETER (TFM) INPUT

The TFM input provides the turbine flowmeter input signal generated by a magnetic pickup, enabling the MC Synergy to calculate and display instantaneous flow rates and accumulated totals. See [Programmable Input Signal Options, page 21](#) for more information.

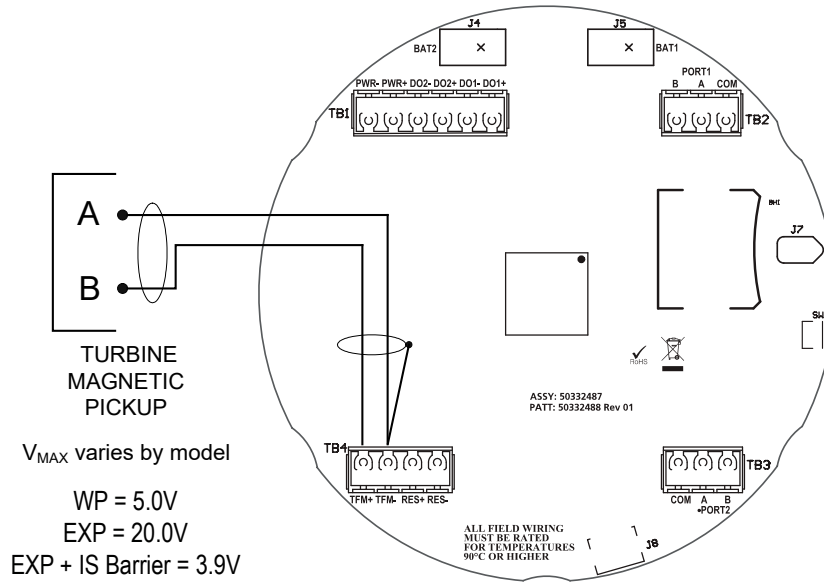

Figure 2.12—Flowmeter input wiring

PULSE INPUT

The pulse input provides a DC voltage input in systems where a preamplifier is inserted between the sensor and the MC Synergy EXP Totalizer. This input can be configured either through the PC software or through the keypad. See [Programmable Input Signal Options, page 21](#) for more information.

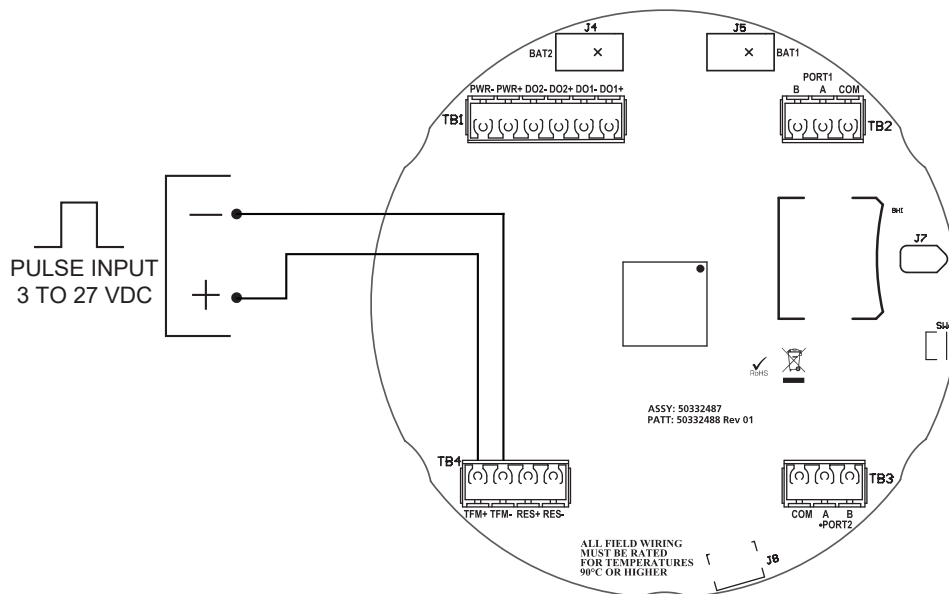

Figure 2.13—Pulse input wiring

CONTACT CLOSURE

The contact closure provides a method of introducing a signal to the input via mechanical switching. The input provides the power for the contact. No additional power is required for the contact closure. This input can be configured either through the PC software or through the keypad. See [Programmable Input Signal Options, page 21](#) for more information.

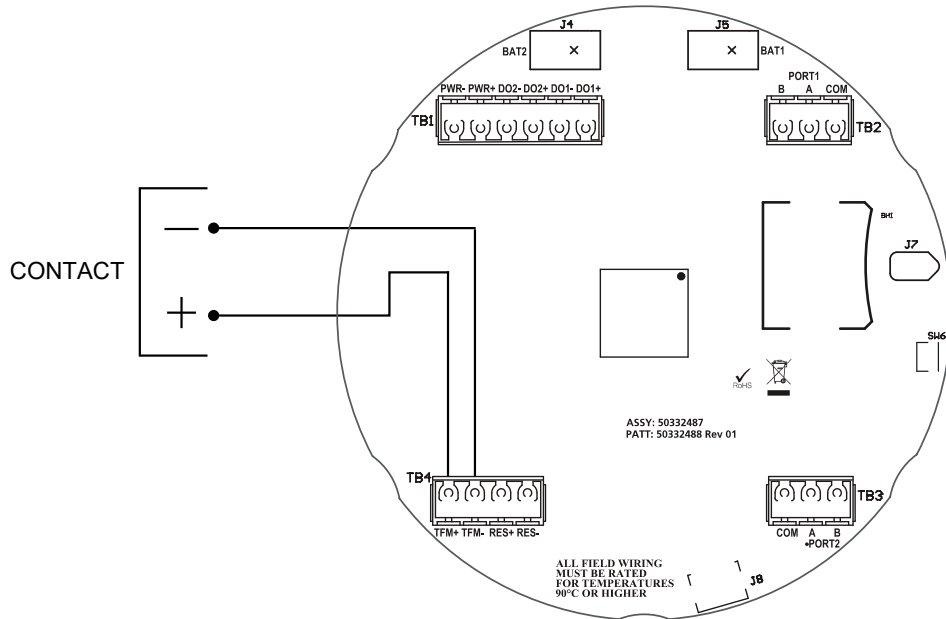

Figure 2.14—Contact input wiring

OUTPUT WIRING

The MC Synergy EXP Totalizer supports five outputs: Two digital outputs (which can be configured as either pulse or frequency outputs), HART/4-20 mA output (HART expansion board), and two RS-485 outputs. Wiring diagrams for each feature are provided below.

DIGITAL OUTPUT

The digital output is an isolated open-drain transistor output. Each device has a pair of digital outputs. Each output can function as a scaled pulse output, status output, or flowmeter frequency output. The circuit's maximum current rating is 6 to 27 VDC @ 60 mA.

When used as a pulse output, each pulse represents a user-defined volume. The pulse duration is user-configurable to a minimum pulse width.

When used as a status output, the output provides the status of configured alarms that are linked to the output. For information on configuring the digital output for use as an alarm/status output, see the MC Synergy Software User Manual.

When used as a flow meter frequency (amp&square) output, the meter signal is represented on the isolated, open-drain transistor output. This output type can be used to transmit the turbine meter signal long distances for use with other peripheral equipment.

For information on configuring the pulse output with the keypad, see [Configure the Pulse Output, page 72](#).

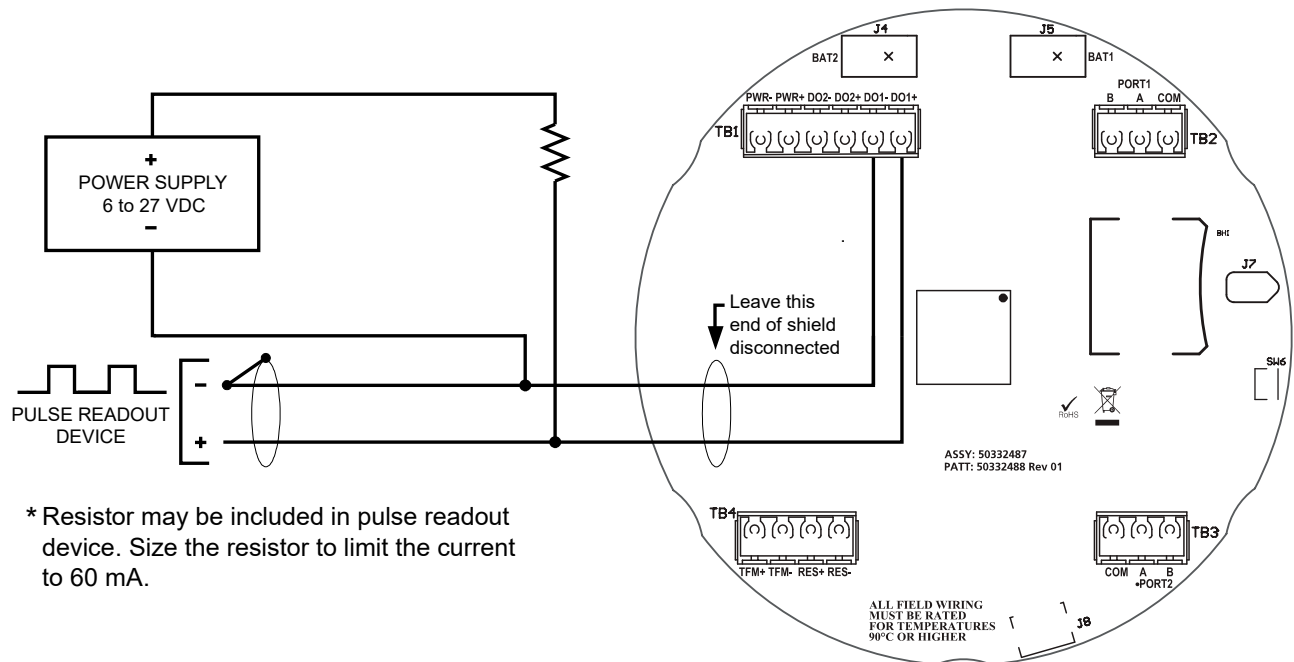

* Resistor may be included in pulse readout device. Size the resistor to limit the current to 60 mA.

Figure 2.15—Pulse output wiring

TABLE 1.7—PULSE OUTPUT COMPARISON

	Frequency Output (A&S)	Pulse Output (Scaled or Precision) ¹
Purpose	Can be used to get a good indication of rate and volume. Rate can be quickly determined as the frequency is much higher and continuous.	Highly accurate representation of volume. Can be used as an indication of rate, but over a longer interval of time.
Pulse Representation	Each pulse represents a single pulse from the meter.	Each pulse represents a user-defined unit of volume.
	Pulses are continuous and evenly spaced.	Pulses are updated every calculation period and generated in bursts. The number of pulses per burst depends on the calculation period, flowing conditions, configured representation of each pulse, and pulse width. The pulses will not be in a continuous, evenly spaced waveform.
Output Signal Frequency Range	0 to 5000 Hz (Signal frequency of NuFlo/Barton meters is 0 to 3500 Hz) Typically requires a high-speed counter of a PLC.	50 Hz Max
Calculations	Mathematic operations need to be performed on the receiving side of the signal. The calibration factor (single or multi-point) must be known as well as the correct conversion to desired units of measurement.	Mathematical operations for calculating volume are performed by the MC Synergy. The MC Synergy performs the linear interpolation of the K-factor and calculates the volume to the user-defined unit. The receiving side simply counts the volumetric pulses.
	Meter factor corrections would need to be calculated	Meter factor correction is incorporated in the representation of each pulse.

TABLE 1.7—PULSE OUTPUT COMPARISON

	Frequency Output (A&S)	Pulse Output (Scaled or Precision)¹
Calibration / Meter Changes	When a meter is replaced, calibration data needs to be entered into the MC Synergy and on the receiving side.	When a meter is replaced, calibration data needs to be entered into the MC Synergy only.
Meter Performance	Meter performance improvements and diagnostic capabilities of the MC Synergy are not represented in the pulses.	Meter performance improvements related to the MC Synergy are represented in the pulses.
Meter Proving	Proving is supported.	Cannot be used as an input to a meter prover due to the low frequency output and the burst nature of the pulses.

1. Both a Scaled pulse output and a Precision pulse output provide a pulse output to calculated volumetric quantities. The only difference is that the precision output is scaled by a power of 10 and aligns to the volume unit on the display. The Scaled pulse output can be scaled by any value and configured in any unit.

ANALOG OUTPUT (EXPANSION BOARD REQUIRED)

The optional Analog Output/HART expansion board which mounts directly to the MC Synergy main board and allows you to output an analog reading representing flow rate while providing loop power to the device over two wires. The loop power supply must be capable of sourcing a minimum of 12.5 to 27 VDC.

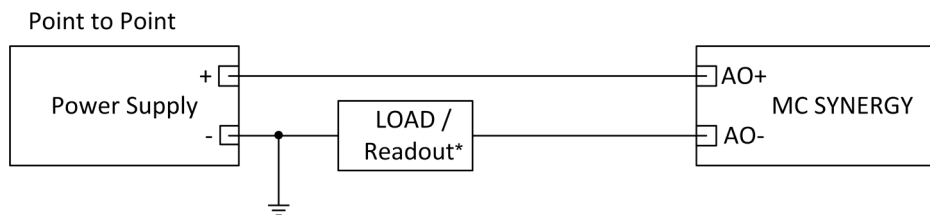

Figure 2.16—Analog output wiring

HART POINT-TO-POINT OR MULTIDROP (EXPANSION BOARD REQUIRED)

The HART output may provide the capability of using the device for HART Point-To-Point or Multidrop communication. HART Point-To-Point may be used to transmit a linear current output that represents flow rate, and has the capability of also transmitting a HART signal which may be used to communicate another parameter to a connected HART readout device. HART Multidrop uses existing analog output wiring to transmit digital information for multiple devices and parameters, using HART protocol, to connected readout devices.

HART Point-To-Point (Figure 2.17, page 47) requires a two-conductor cable connected to an 12.5 to 27 VDC power supply (voltage required is dependent on loop resistance) and a current readout device and HART Modem located in the remote location. In Figure 2.19, page 48, the mathematical relationship between loop voltage and load resistance is given. For example, if a power supply voltage of 24 volts is available to power the current loop, the maximum load resistance would be 800 ohms. In addition to the HART Modem, a handheld HART terminal may be connected to read the HART messages.

HART Multidrop (Figure 2.18, page 47) requires a two conductor cable connected to an 12.5 to 27 VDC power supply (which may be supplied by the HART input/output system), other HART-enabled field devices (up to 63 devices), and a HART input/output system located in a remote location. In addition to the HART Modem, a handheld HART terminal may be connected to read the HART messages.

For information on configuring the HART output with the keypad, see [Configure the HART Interface, page 63](#).

Note In HART multidrop configurations, power may be provided by an external supply or by the HART interface modem.

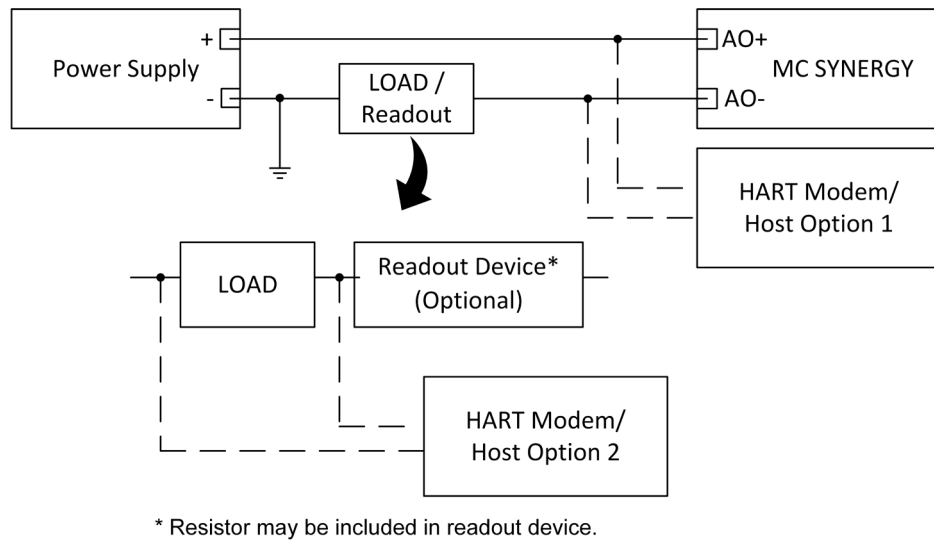

Figure 2.17—HART point-to-point wiring

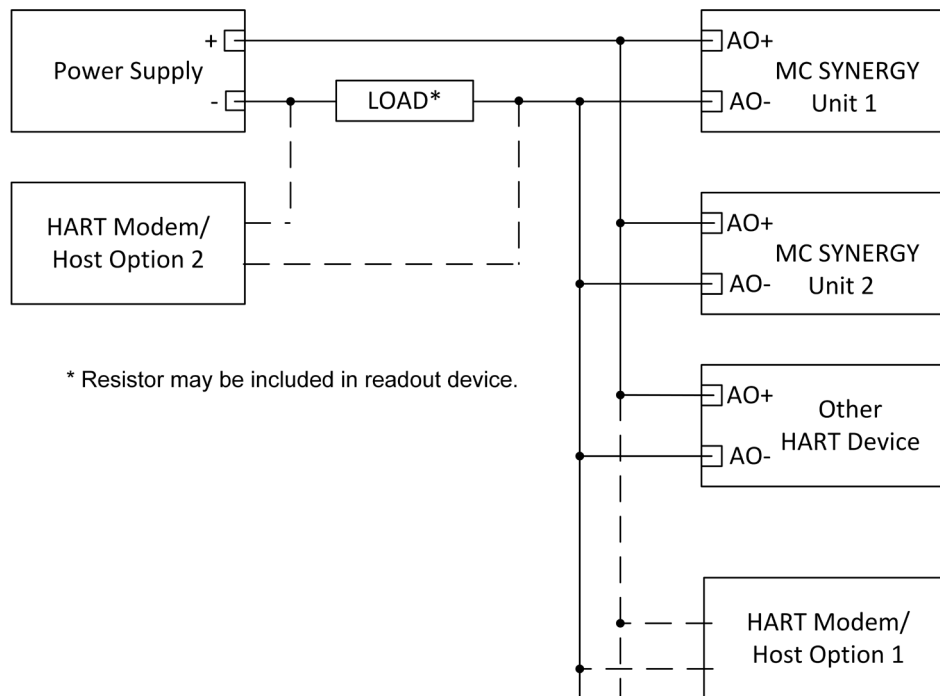

Figure 2.18—HART multidrop wiring

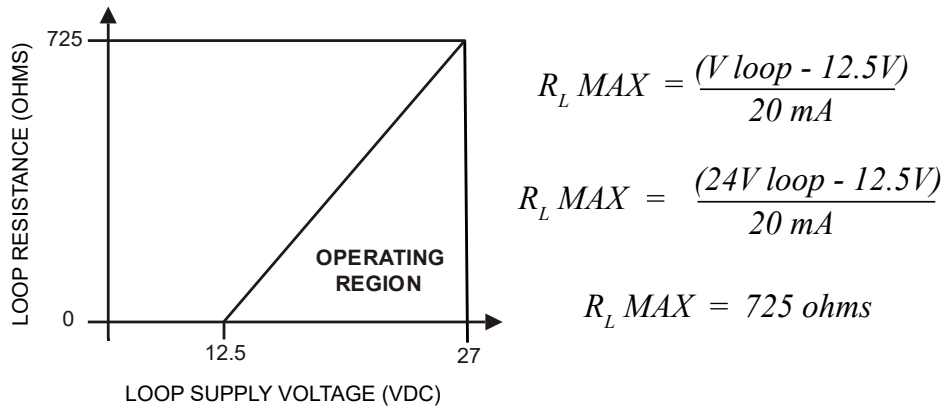

Figure 2.19—Loop supply vs load resistance

ETHERNET COMMUNICATION (EXPANSION BOARD REQUIRED)

The optional Ethernet expansion board allows you to connect to the device over a network instead of through a serial connection.

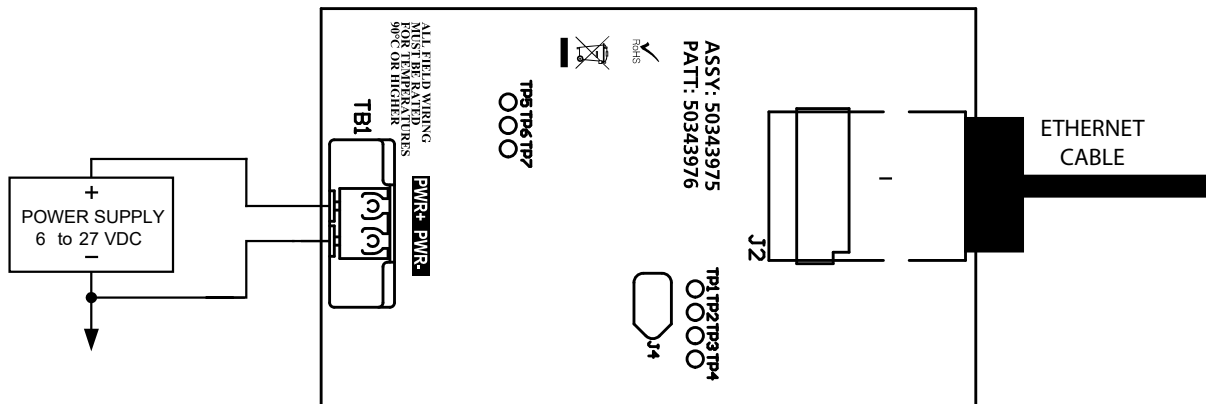

Figure 2.20—Ethernet expansion board wiring

When wiring the optional Ethernet expansion board, connect external power to the expansion board. The expansion board will provide power to the main board. To read the voltage level of the external supply, connect the external power to the main board also.

Important Connect external power to the Ethernet Expansion Board when installed. Power must be supplied to the expansion board for Ethernet to function.

RS-485 OUTPUT

Only one of the RS-485 outputs is required for communication with the PC software. Wiring diagrams are provided for a permanent connection (Figure 2.21, page 49) like a SCADA network connection, as well as for temporary laptop connections using an RS-485 converter (Figure 2.22, page 49) assembly with a USB or RS-232 connector. Either or both RS-485 ports may be used for communication.

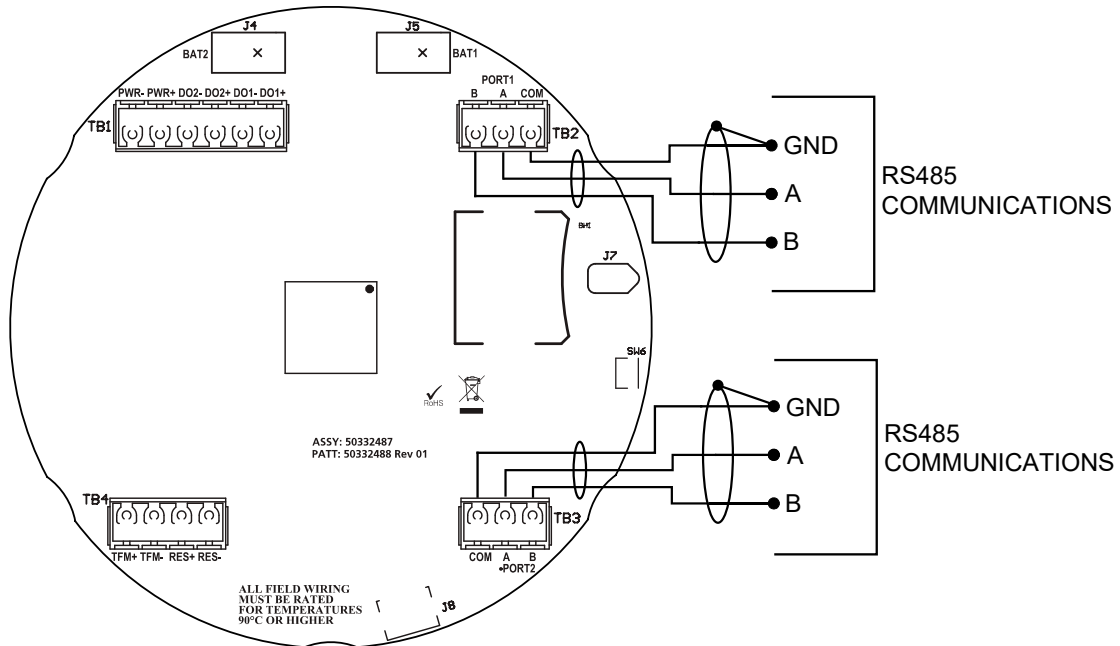

Figure 2.21—RS-485 output (permanent connection)

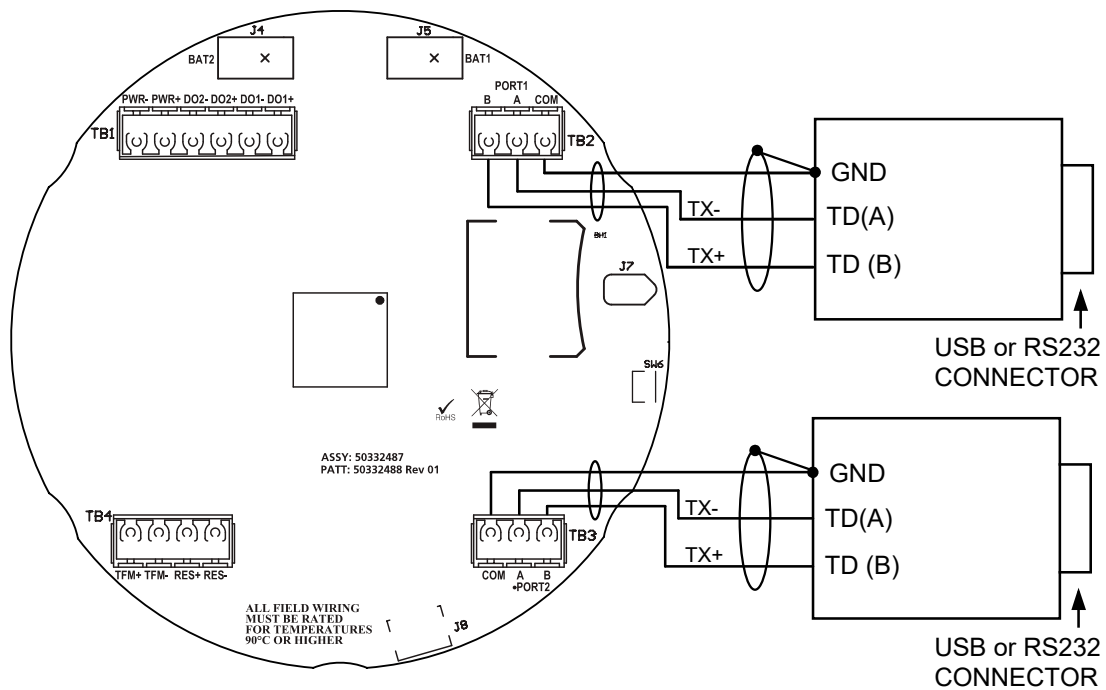
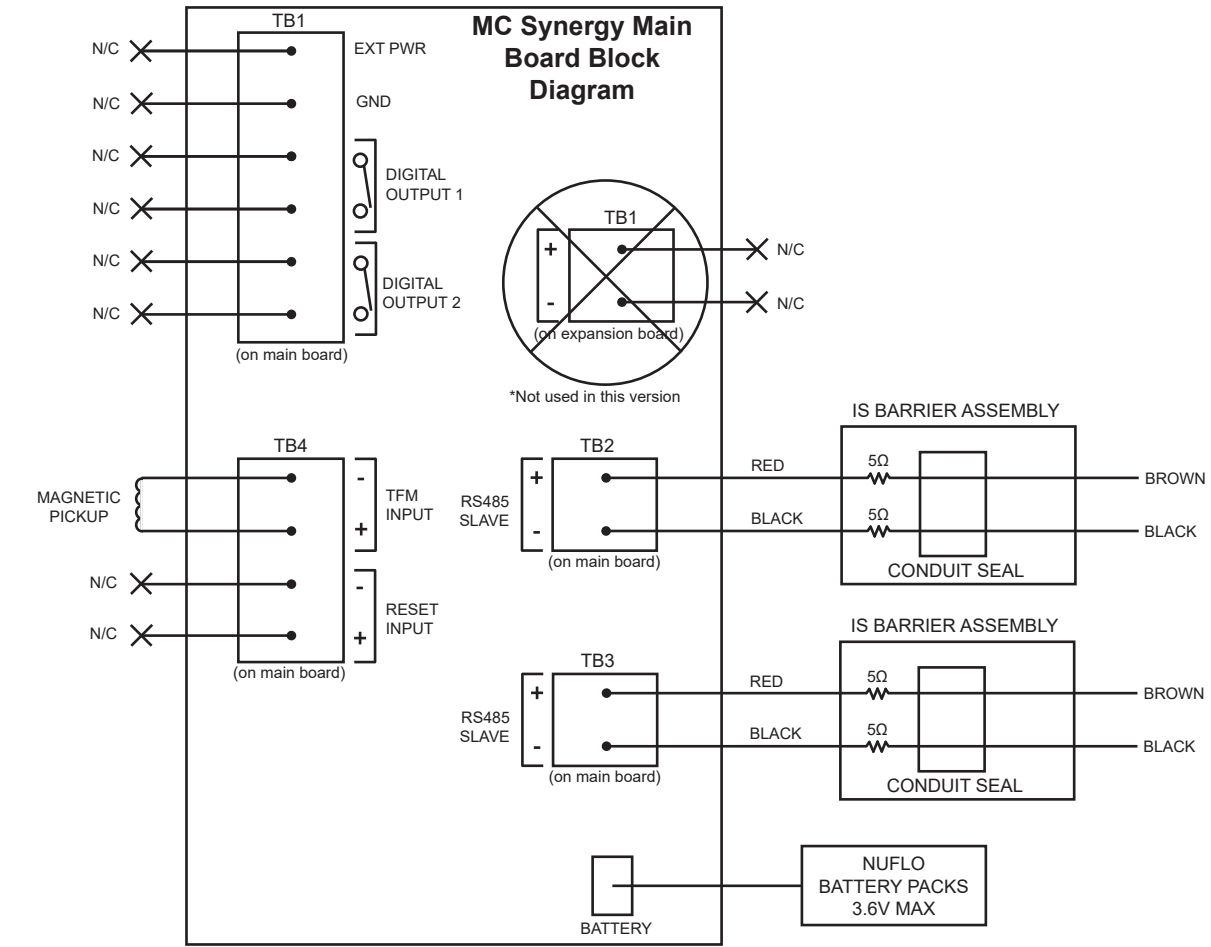

Figure 2.22—PC/laptop wiring using an RS-485 communications converter assembly to connect to an RS-232 or USB port. A USB A/B communications cable is also required to connect the converter assembly to a standard laptop USB port. Converter assemblies and USB cables are available from Sensia.

Additionally, the RS-485 outputs are approved for intrinsically safe installations. An intrinsically safe installation requires an intrinsically safe barrier assembly with a conduit seal (Figure 2.23). In such installations, only the turbine flowmeter input may be used.



NOTES:

1. WHEN RS-485 OUTPUT IS USED AS SHOWN, ONLY THE TFM (TURBINE FLOWMETER INPUT) MAY BE USED. NO OTHER INPUT OR OUTPUT.
2. TURBINE INPUT MUST BE SIMPLE INDUCTIVE PICKUP. EXTERNALLY POWERED DEVICES ARE NOT ALLOWED. THE PICKUP OUTPUT MUST BE LESS THAN 3.9V PEAK, 2.76 VRMS.

RS-485 OUTPUT ENTITY PARAMETERS

$V_{max} = 20V$	$V_{oc} = 3.9V$
$I_{max} = 630mA$	$I_{sc} = 390mA$
$C = 0\mu F$	$C_a = 100\mu F$
$L = 0\mu H$	$L_a = 249\mu H$

Figure 2.23—Intrinsically safe RS-485 connection, based on control drawing X-371226

SOFTWARE INSTALLATION AND CONNECTION

You can configure the MC Synergy Totalizer, calibrate inputs, download logs, and view data using Sensia's complimentary MC Synergy software. See the MC Synergy Software User Manual for additional info.

INSTALLATION

To install the software, perform the following steps:

1. From your PC's browser, navigate to this web page:
<https://www.sensiaglobal.com/measurement/turbine-flow-electronics>
2. Click NUFLO MC SYNERGY, scroll to Product Resources, and click SOFTWARE to access Download links.
3. Download the NUFLO MC Synergy software. For viewing, analyzing, and exporting data following MC Synergy downloads, download the NUFLO ScanData software also.
4. Run each of the install programs to install both software programs on your PC or laptop.

CONNECT TO THE MC SYNERGY

Before connecting your PC or laptop to the MC Synergy, make sure you have the necessary communications converter assembly, and if connecting via USB, the necessary USB A/B communications cable. See (Figure 2.22, page 49) and the spare parts list starting on page 86 for details.

1. Wire your PC or laptop to one of the two communications ports on your MC Synergy device per the RS-485 wiring diagrams on page 49. Connect the USB Type A/B cable if using a standard laptop USB port.
2. Open the MC Synergy Software installed on your PC or laptop.
3. Click CONNECT TO DEVICE on the welcome screen.
4. Under Select a Connection Method, click EXPRESS CONNECT (Figure 2.24).
5. Select the serial port that is connected to your MC Synergy device.
6. Click EXPRESS to scan for connected devices and initiate the connection to your MC Synergy device.

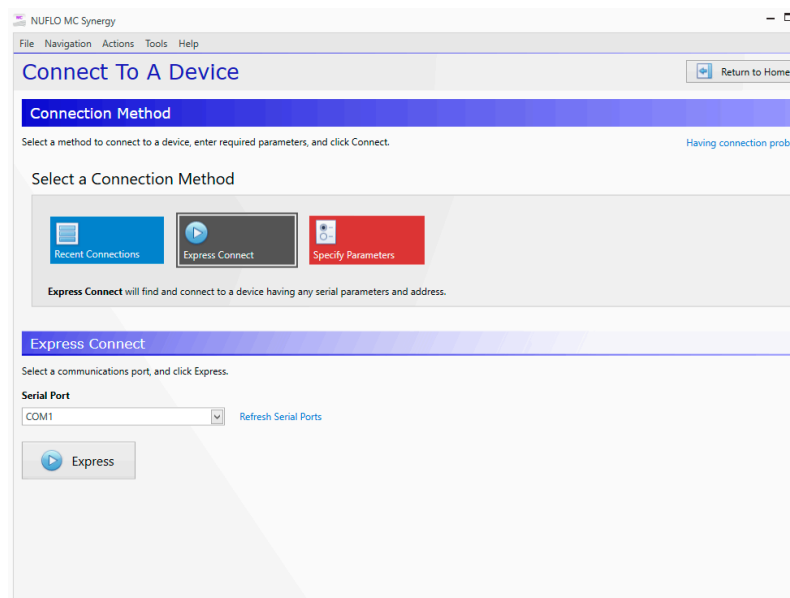

Figure 2.24—Software connection screen

Page intentionally left blank

Section 3: Device Configuration via the Keypad

Configuration of the MC Synergy™ EXP Totalizer is a simple matter of entering necessary parameters into the instrument.

The process depends on how the instrument will be used. The capacitive keypad can be used to configure the device through the glass for liquid or gas measurement using pre-programmed units, or for liquid measurement using a calculated divisor. When pre-programmed units are used, the MC Synergy EXP Totalizer automatically calculates the divisor for volume calculation and the rate multiplier for flow rate calculation, making calibration quick and easy.

Important For compensated gas measurement, or gas or liquid measurement requiring multipoint (2- to 12-point) linearization, calibration must be performed with the PC software or the keypad.



WARNING

To prevent ignition of hazardous atmospheres, do not remove the cover while circuits are alive. **DO NOT OPEN WHEN AN EXPLOSIVE GAS ATMOSPHERE IS PRESENT.** Under normal conditions, the MC Synergy EXP Totalizer poses no hazard when opened in a safe area.

Use [Figure 3.1, page 54](#) and [Figure 3.2, page 55](#) to familiarize yourself with the keypad menu navigation. The following links provide quick access to detailed information about specific menus or functions.

- [Operating Mode, page 53](#)
- [Acknowledge Active Alarms, page 55](#)
- [Clear the Grand Total, page 56](#)
- [Configure the Display, page 56](#)
- [Configure Device Date and Time, page 59](#)
- [Configure Communication Ports, page 60](#)
- [Configure a 4-20 mA Rate Output, page 61](#)
- [Configure the HART Interface, page 63](#)
- [Configure Ethernet Communication, page 67](#)
- [Enable/Reset Bluetooth Communication, page 68](#)
- [Configure Input Type, Sensitivity and Meter Kit Alarm, page 70](#)
- [Configure the Pulse Output, page 72](#)
- [Load Default Values, page 73](#)
- [Enter Meter Factors, page 74](#)
- [Enter K-Factors, page 77](#)

OPERATING MODE

When the MC Synergy is in the routine operating mode, the display will show current rate and grand total or the user-selected parameters chosen for monitoring operations.

From the operating mode, you can access configuration settings by pressing the MENU button and using the INC button to advance through all supported configurations. See [Figure 3.1, page 54](#) for an overview of the menu architecture.

From the operating mode, you can access calibration settings by pressing the KFACT button ([Figure 3.2, page 55](#)).

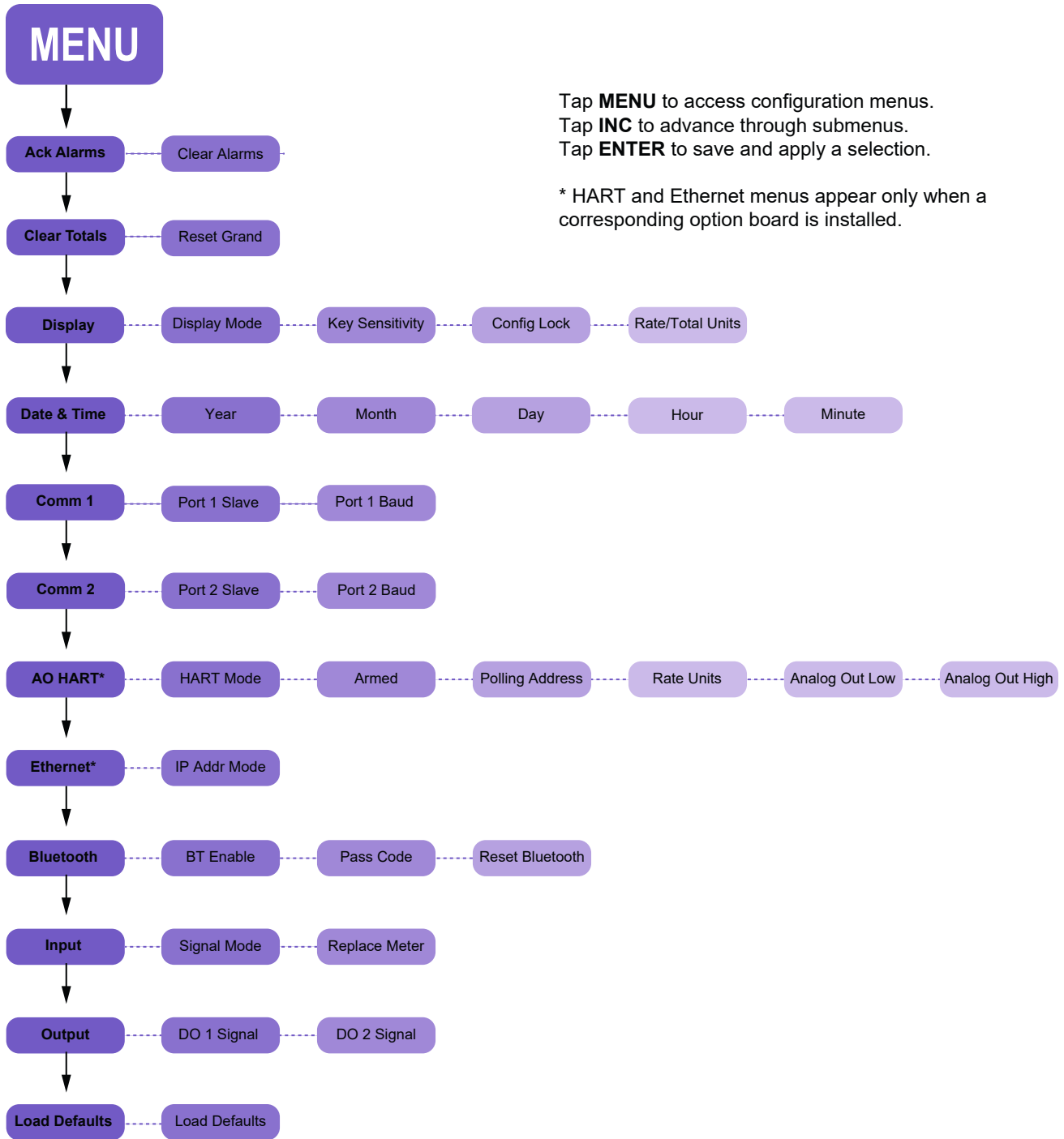

Figure 3.1—MENU button navigation

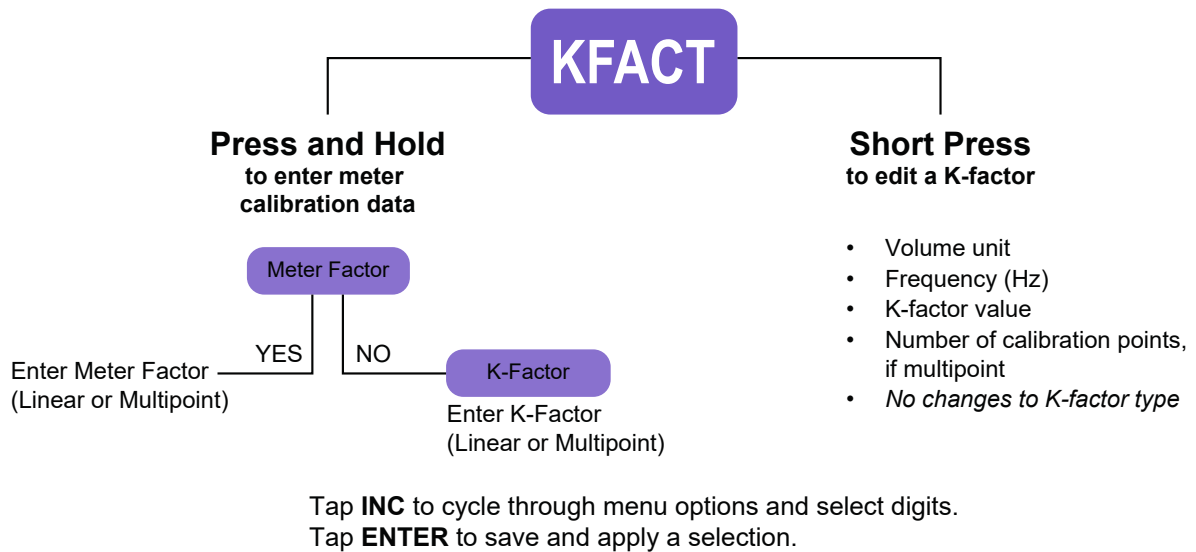

Figure 3.2—KFACT button navigation

EXIT A CONFIGURATION MENU

If you accidentally enter a menu, you can exit to the standard operating display by pressing MENU. However, in most cases, any changes that you have committed by pressing ENTER will be automatically saved and applied at the time of exit, even if you exited the menu before making all related selections. The message "Saving" will appear on the LCD to alert you to this event.

If you feel you may have made an unintended change, simply return to the menu to verify your selections.

ACKNOWLEDGE ACTIVE ALARMS

The act of acknowledging alarms silences all active alarms. This includes user alarms, turbine alarms, and system alarms. Using this function is particularly useful if the alarm is latching, as latching alarms will not unlatch until the device is reset or the alarm is acknowledged. If an alarm condition is still present, the alarm will re-activate after acknowledgement.

To acknowledge all alarms via the keypad:

1. Tap MENU.
2. Tap ENTER to enter the Acknowledge Alarms menu.
3. Tap ENTER to acknowledge all active alarms.

Alarms will reactivate if one or more alarm conditions are still present.

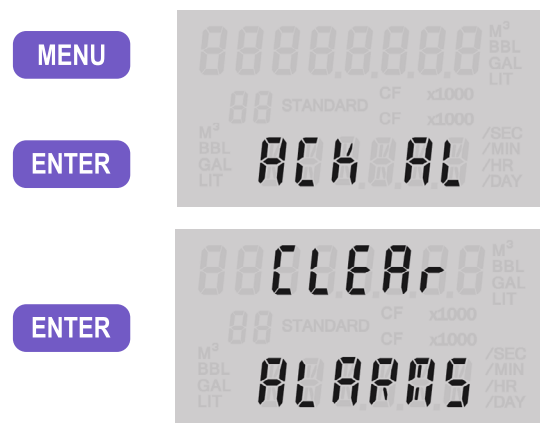

CLEAR THE GRAND TOTAL

This procedure will clear the grand total on the device. It will not clear interval, daily, monthly, or polling totals. The grand total can also be cleared from the PC software, Digital Dataplate app, or a HART command.



CAUTION

This action is non-reversible. Pressing ENTER to select CLEAR TOTALS menu will zero the grand total. You will not enter the CLEAR TOTALS menu before performing this function.

To clear the grand total via the keypad:

1. Tap MENU.
2. Use INC to advance to the Clear Totals menu.
3. Tap ENTER to clear the grand total.
4. As the reset commences, the message "Reset Totals" appears.



CONFIGURE THE DISPLAY

The Display Configuration Menu allows you to choose the parameters to be displayed on the LCD during operation. You will also configure units of measurement and decimal position for total and rate, optimize keypad sensitivity, and enable or disable a built-in configuration lock from this menu. By default, the grand total volume and flow rate appear in the LCD during operation.

To configure display settings via the keypad:

- | | |
|----------------------------------|--|
| Enter Display Configuration Menu | 1. Tap MENU. |
| | 2. Use INC to advance to the Display Configuration menu. |
| | 3. Tap ENTER to enter the menu. |



- | | |
|-------------------------|---|
| Select the Display Mode | 4. Use INC to toggle display modes. Options: rAtE-tot (rate and total) or uSEr SEL (pre-selected parameters). |
| | 5. Press ENTER to save and continue. |



- | | |
|---------------------------|--|
| Select Keypad Sensitivity | 6. Use INC to choose a sensitivity setting. Option: dEFALt , Lo , and oFF . |
| | 7. Press ENTER to save and continue. |



Select Configuration Lock	<p>8. Use INC to toggle no/yes to disable/enable the keypad lock which prevents access by unauthorized personnel.</p> <p>9. Press ENTER to save and continue.</p>	<p>INC</p> <p>ENTER</p>	<p>The LCD display shows 'no' in the upper display and 'CONF 19' in the lower display. The background shows various unit and multiplier options like M³, BBL, GAL, LIT, STANDARD, CF, x1000, /SEC, /MIN, /HR, /DAY.</p>
Select Total Volume Units	<p>10. When the volume unit is blinking, use INC to choose the total display unit. Available selections will cycle first through units, then through units with x1000 multiplication factor (recommended for total values that exceed the characters in the LCD). "Ed" (edit mode) will appear on the LCD (not shown in these examples).</p> <p>11. Tap STEP to continue. The decimal in the upper (total) display will flash.</p>	<p>INC</p> <p>STEP</p>	<p>The LCD display shows '00000000.0' in the upper display and '000000.0' in the lower display. The background shows unit and multiplier options.</p>
Select Total Volume Decimal Position	<p>12. Use INC to choose the desired decimal position in the total display.</p> <p>13. Tap STEP to continue. The flow rate volume unit will flash.</p>	<p>INC</p> <p>STEP</p>	<p>The LCD display shows '00000000.0' in the upper display and '000000.0' in the lower display. The background shows unit and multiplier options.</p>
Select Flow Rate Volume Units	<p>14. Use INC to choose the flow rate volume unit.</p> <p>15. Tap STEP to continue. The flow rate unit will flash.</p>	<p>INC</p> <p>STEP</p>	<p>The LCD display shows '00000000.0' in the upper display and '000000.0' in the lower display. The background shows unit and multiplier options.</p>
Select Flow Rate Units	<p>16. Use INC to choose the flow rate unit.</p> <p>17. Tap STEP to continue. The decimal in the lower (flow rate) display will flash.</p>	<p>ENTER</p> <p>STEP</p>	<p>The LCD display shows '00000000.0' in the upper display and '000000.0' in the lower display. The background shows unit and multiplier options.</p>
Select Flow Rate Decimal Position.	<p>18. Use INC to choose the desired decimal position for the flow rate display.</p> <p>19. Tap ENTER to save and exit the display configuration.</p>	<p>INC</p> <p>ENTER</p>	<p>The LCD display shows '00000000.0' in the upper display and '000000.0' in the lower display. The background shows unit and multiplier options.</p>

CONFIGURE THE DISPLAY - SHORTCUT

To change the display units of measure and/or decimal configuration of display parameters without scrolling through the master menu, use the following keypad shortcut.

1. Press and hold the MENU button until the top row unit flashes. An “Ed” will appear on the LCD to acknowledge the device is in Edit mode.
2. Proceed with steps 10 through 19 from the Configure Display menu on [page 57](#) to make the desired changes.

MENU

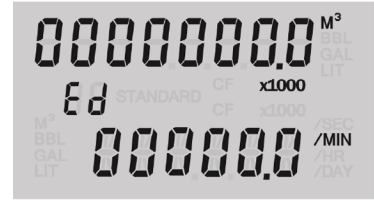

CONFIGURE MORE DISPLAY PARAMETERS

If you prefer to add additional parameters to your display, you can pre-configure up to eight display parameters using the PC software or the Digital Data Plate application. When user-selected parameters are pre-configured, you can use the keypad menu to toggle between the rate/total and pre-configured displays.

The PC software menu for selecting display parameters is shown in [Figure 3.3](#). When more than two display parameters are configured, parameters will scroll across the bottom row of the LCD in the order they are entered in the Display Items list.

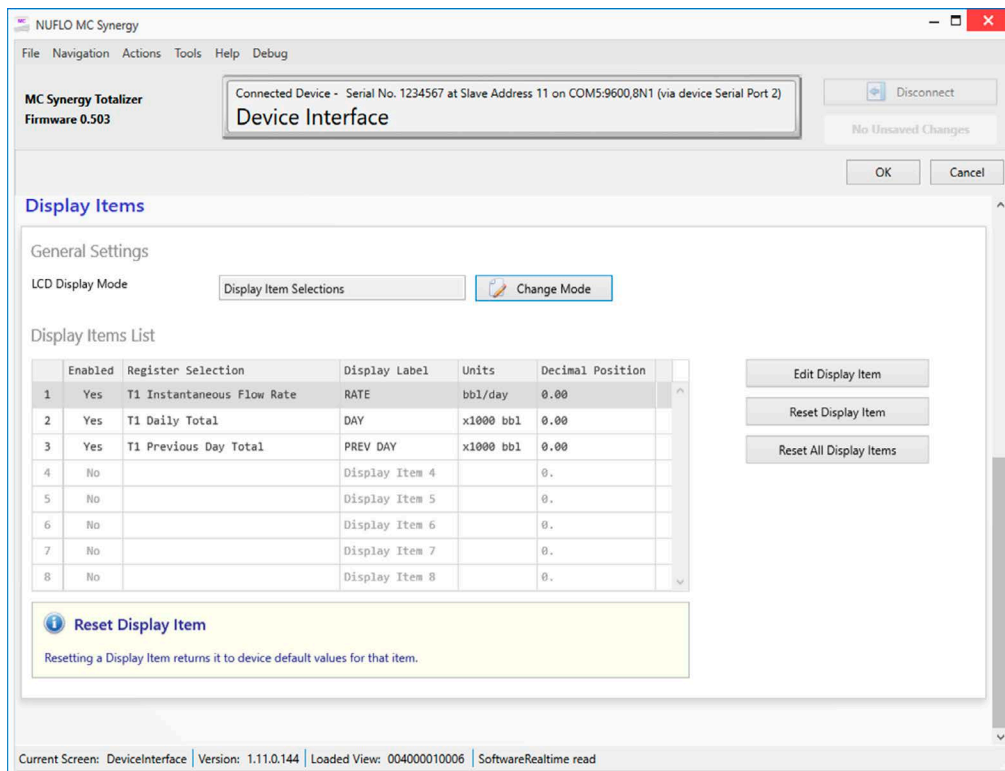



















Figure 3.3—PC software configuration of user-selected display parameters

CONFIGURE DEVICE DATE AND TIME

Configuring the date and time is important to ensure that the logs and archives that are created have an accurate time stamp for the local time and current date. The date and time may be configured via the keypad. However, the date/time sync function supported by the Digital Data Plate app and the PC software is recommended, as this will provide a higher degree of accuracy during configuration.

To configure the device date and time via the keypad:

1. Tap MENU. 
2. Use INC to advance to the Date & Time Configuration menu. 
3. Tap ENTER to enter the menu. The rightmost digit of the year will flash. 
4. Use INC to change the value for the flashing digit (in this example, "3") 
5. Use STEP to select the next digit to the left. 
6. Repeat steps 4 and 5 to enter all four digits of the current year. Tap ENTER to save and continue. 
7. Use INC and STEP to select the current month. INC displays the month AFTER the current selection and STEP displays the month PRIOR to the current selection.  
8. Tap ENTER to save and continue. 
9. Use INC and STEP to select the current date. INC displays the day AFTER the current selection and STEP displays the day PRIOR to the current selection.  
10. Tap ENTER to save and continue. 
11. Use INC and STEP to select the current hour. INC displays the hour AFTER the current selection and STEP displays the hour PRIOR to the current selection.  
12. Tap ENTER to save and continue. 
13. Use INC and STEP to select the current minute. INC displays the minute AFTER the current selection and STEP displays the minute PRIOR to the current selection.  
14. Tap ENTER to save the minute selection and exit the menu. 



CONFIGURE COMMUNICATION PORTS

Two communication ports may be used to communicate with the MC Synergy. Both are configured in separate menus. Configure Communication Port 1, and then proceed to configure Communication Port 2.

The slave address is a setting used in Modbus communications to identify a device connected to a communication port. The range of valid slave addresses spans 1 to 65535. If the Modbus request message contains the matching address, the device will respond to the request. Contact the network administrator to ensure that the assigned slave address is unique and will not collide with other devices during communication.

The baud rate is the number of bits per second that are transmitted or received over the serial port. This setting must match the setting of the master device polling the MC Synergy EXP Totalizer or the serial port.

CONFIGURE PORT 1

To configure Communication Port 1 via the keypad:

1. Tap MENU.
2. Use INC to advance to the Comm 1 menu.
3. Tap ENTER to enter the menu. The rightmost digit of the slave address will flash. "P1" identifies port 1 as the communications port being configured.
4. Enter the slave address, using INC to change the value for the selected digit.
5. If more than one digit is needed, use STEP to advance to the next digit and use INC to change the value.
6. Tap ENTER to save the selection and continue to the baud rate selection.
7. Use INC to advance to the desired baud rate.
8. Tap ENTER to save the selection and exit the menu.



CONFIGURE PORT 2

To configure Communication Port 2, repeat steps 1 through 8 from the previous procedure, selecting Comm 2 menu in step 2.



CONFIGURE A 4-20 MA RATE OUTPUT



CAUTION

Before configuring a 4-20 mA rate output, disconnect or disable all peripheral equipment connected to the 4-20 mA current loop. Configuring and testing the 4-20 mA output feature with the peripheral equipment in operation may cause false alarms or erroneous operation of the peripheral device or associated equipment.

An optional analog expansion board provides a 4-20 mA output that may be configured to represent flow rate. Zero and full-scale values can be configured to represent any flow rate range within the range of the flowmeter. The low (or zero) setting is the flow rate value that will produce a 4-mA output. The high (or full-scale) setting is the flow rate value that will produce a 20-mA output. Typically, the high value is greater than the low value; this scenario, shown in [Figure 3.4](#), is defined as “direct mode.”

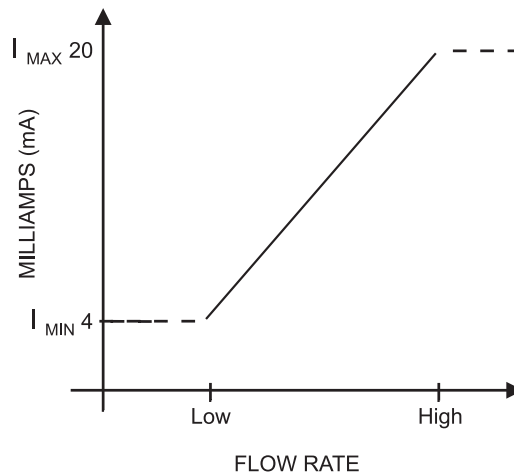

Figure 3.4—4-20 mA output configuration

Flow rates between the minimum and maximum rate setpoints will result in an output of current between 4 mA and 20 mA according to the following calculation:

$$I_{OUT} = \frac{I_{MAX} - I_{MIN}}{High - Low} \times [RATE_{CURR} - Low] + I_{MIN}$$

Where:

I_{OUT} = output current , I_{MAX} = maximum current output (20 mA), I_{MIN} = minimum current output (4 mA)

High = programmed flow rate that produces a 20-mA output

Low = programmed flow rate that produces a 4-mA output

$RATE_{CURR}$ = flow rate

Important Analog output configuration is combined with HART configuration in a single menu. Both features are supported by an optional expansion board. See [Analog Output \(Expansion Board required\)](#), page 46 for instructions on installing and wiring the 4-20 mA rate output. See also [Loop Power \(Analog Output/HART Expansion Board\)](#), page 40.

To configure the 4-20mA rate output:

1. Tap MENU.
2. Use INC to advance to the HART menu.
3. Tap ENTER to enter the menu.
4. Use INC to select the 4-20 out mode of operation.
5. Tap ENTER to save and continue.
6. Use INC to toggle-select NO to the “Armed” prompt. This setting is for HART use only.
7. Tap ENTER to execute the selected action.
8. Tap ENTER to bypass the polling address. This setting is for HART use only.
9. Use INC to select a rate unit. The menu will progress through every combination of volume and time units.
10. Tap ENTER to save and continue.
11. The decimal position of the Analog Low Limit setting will flash. Use INC to choose the decimal point position for the low-flow limit.
12. Tap STEP to select the right-most digit of the low-flow limit. Use INC to change the value of the flashing digit.
13. Repeat step 12 to enter all digits of the low-flow limit.
14. Tap ENTER to save and continue.

MENU

INC

ENTER

INC

ENTER

INC

ENTER

ENTER

INC

ENTER

INC

STEP

INC

ENTER



15. The decimal position of the Analog High Limit setting will flash. Use INC to choose the decimal point position for the high-flow limit.
16. Tap STEP to select the right-most digit of the high-flow limit. Use INC to change the value of the flashing digit.
17. Repeat step 16 to enter all digits of the high-flow limit.
18. Tap ENTER to save and exit the Configuration menu.

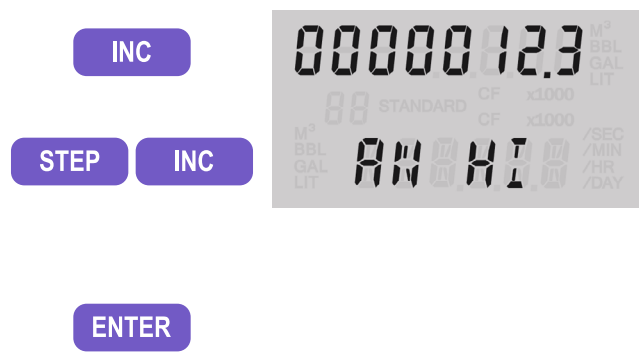

To calibrate (scale) the analog output, login to the PC software and select the Manage Device menu tab. Scroll down the page and select the Calibrate Analog Output button for a step-by-step procedure in setting trim offset and trim scale (Figure 3.5).

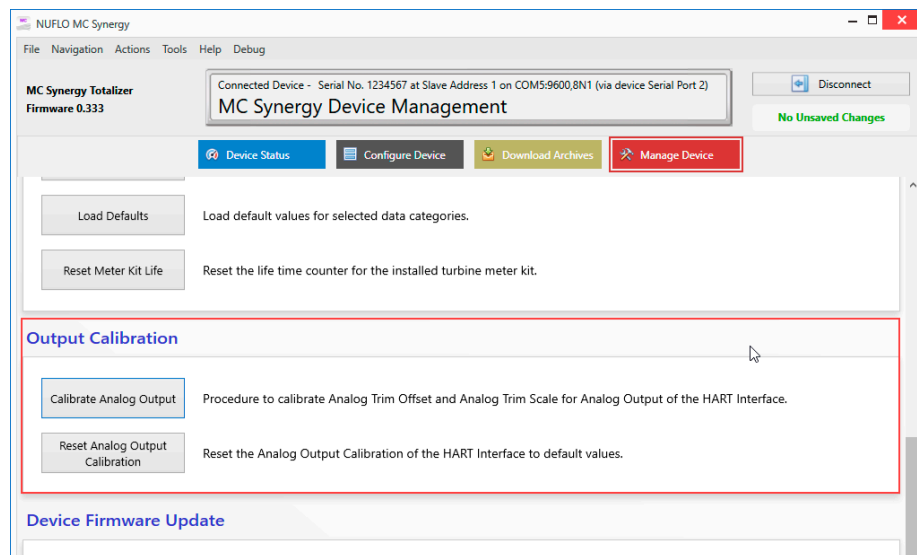

Figure 3.5—Analog output calibration procedure

CONFIGURE THE HART INTERFACE



CAUTION

Before configuring a 4-20 mA rate output, disconnect or disable all peripheral equipment connected to the 4-20 mA current loop. Configuring and testing the 4-20 mA output feature with the peripheral equipment in operation may cause false alarms or erroneous operation of the peripheral device or associated equipment.

The MC Synergy EXP Totalizer’s optional HART expansion board provides a 4-20 mA output that may be configured to represent flow rate (if in HART Point-To-Point mode). Zero and full-scale values can be configured to represent any flow rate range within the range of the flowmeter. The low (or zero) setting is the flow rate value that will produce a 4-mA output. The high (or full-scale) setting is the flow rate value that will produce a 20-mA output. Typically, the high value is greater than the low value; this scenario is defined as “direct mode” in Figure 3.6, page 64.

The 4-20 mA analog output low alarm activates when the flow rate drops to 1.25% below the configured flow rate range, and provides an output of 3.8 mA. The high alarm activates when the flow rate reaches 103.25% of the configured flow rate range and provides an output of 22 mA.

Note If HART is a point-to-point (4 to 20 mA) configuration, the polling address will be “0”. If it is a Multidrop configuration, the polling address must be “1” or greater (all devices in the loop must have unique addresses).

Note If HART is a multidrop configuration, the analog signal is not measured. The 4-20 mA output is fixed at 4 mA and used only for power. It will not operate as a 4-20 mA analog output. All of the data is acquired using HART.

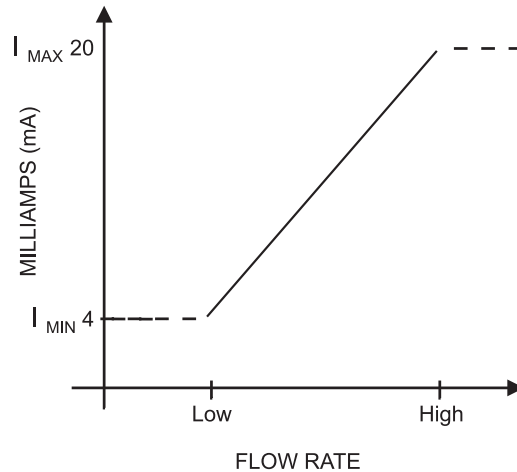

Figure 3.6—4-20 mA output configuration

Flow rates between the minimum and maximum rate setpoints will result in an output of current between 4 mA and 20 mA according to the following calculation:

$$I_{OUT} = \frac{[I_{MAX} - I_{MIN}]}{High - Low} \times [RATE_{CURR} - Low] + I_{MIN}$$

Where:

I_{OUT} = output current , I_{MAX} = maximum current output (20 mA), I_{MIN} = minimum current output (4 mA)

High = programmed flow rate that produces a 20-mA output

Low = programmed flow rate that produces a 4-mA output

$RATE_{CURR}$ = flow rate

Important Analog output configuration is combined with HART configuration in a single menu. Both features are supported by an optional expansion board. See [HART Point-To-Point or Multidrop \(Expansion Board required\)](#), page 46 for instructions on installing and wiring the 4-20 mA rate output. See also [Loop Power \(Analog Output/HART Expansion Board\)](#), page 40.

To configure HART communications and the 4-20mA output:

1. Tap MENU.
2. Use INC to advance to the HART Configuration menu.
3. Tap ENTER to enter the menu.
4. Use INC to select the HART mode of operation.
 - 4-20 Out (Point-To-Point) enables the output to transmit the flow rate.
 - Multidrop allows multiple HART devices to be connected through the same wire. If you select Multidrop, the menu will prompt you to save your selections and exit the menu at step 10. No further prompts will be displayed.
5. Tap ENTER to save and continue.
6. Use INC to toggle YES or NO to this “Armed” prompt.
 - Select YES to make the MC Synergy discoverable by a host device using command 73 (“find device”).
 - In all other instances, select NO.
7. Tap ENTER to execute the selected action.
8. Enter the polling address, using INC to change the value of the selected digit.
9. Use STEP to advance to the second digit if a two-digit polling address is desired. Use INC to change the value of the selected digit.
10. Tap ENTER to save and continue.
11. Use INC to select a rate unit. The menu will progress through every combination of volume and time units.
12. Tap ENTER to save and continue.
13. The decimal position of the Analog Low Limit setting will flash. Use INC to choose the decimal point position for the low-flow limit.

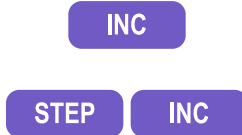

14. Tap STEP to select the right-most digit of the low-flow limit. Use INC to change the value of the flashing digit.
15. Repeat step 14 to enter all digits of the low-flow limit.
16. Tap ENTER to save and continue.
17. The decimal position of the Analog High Limit setting will flash. Use INC to choose the decimal point position for the high-flow limit.
18. Tap STEP to select the right-most digit of the high-flow limit. Use INC to change the value of the flashing digit.
19. Repeat step 18 to enter all digits of the high-flow limit.
20. Tap ENTER to save and exit the HART Configuration menu.

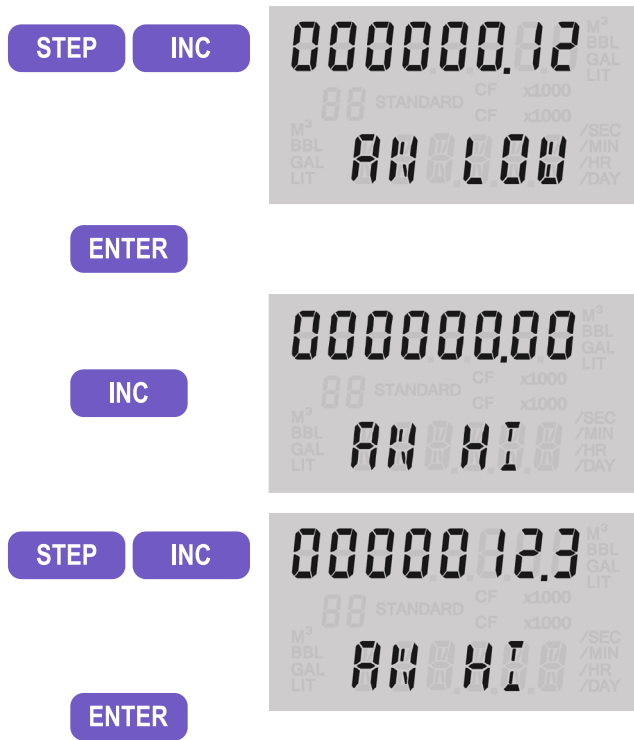

HART ALARM TROUBLESHOOTING

When configuring the MC Synergy’s HART interface, be aware of the dependency between a turbine meter flow range and the 4-to-20 mA flow range to prevent unexpected alarms. Entering an Analog High Flow Rate value that exceeds your meter’s Flow Range - Max value will trigger a HART warning in your HART field communication device.

The PC software interface and the Digital Data Plate application present the meter’s Flow Range Max value in HART rate units on the HART configuration screen, making it easy to check the compatibility of these values (Figure 3.7).

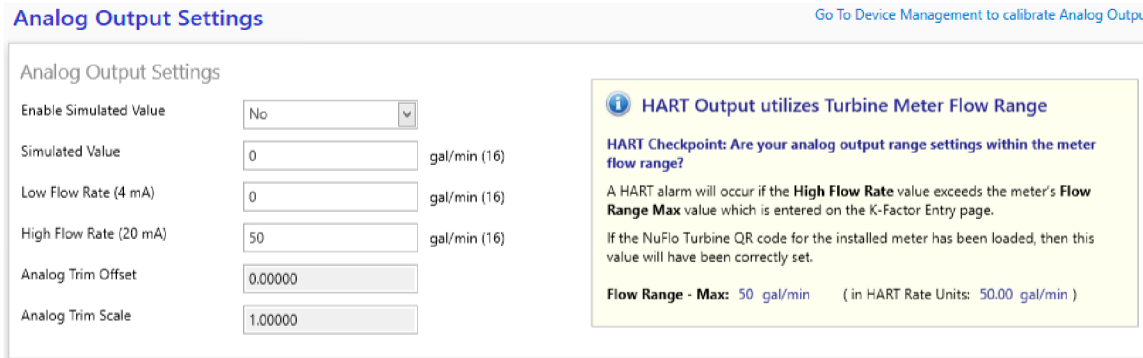

Figure 3.7—Verification of HART analog output range configuration

CONFIGURE ETHERNET COMMUNICATION

The optional Ethernet expansion board has an Ethernet port. Through this port you may transmit Modbus information using either the Modbus-TCP or Modbus Over TCP protocol. For additional information, see [Ethernet Communication via Expansion Board, page 29](#). For instructions on installation and wiring, see [Ethernet Power \(Ethernet Expansion Board\), page 40](#) and [Ethernet Communication \(Expansion Board Required\), page 48](#).

To configure Ethernet communications:

1. Tap MENU.
2. Use INC to advance to the Ethernet Configuration menu.
3. Tap ENTER to enter the menu.
4. Select an IP address mode. Use INC to choose either DHCP (Dynamic Host Configuration Protocol) or STATIC IP addressing.
5. Tap ENTER to save and exit the Ethernet Configuration menu.
6. If the IP address mode is STATIC, configure the dedicated IP address in PC software or the Digital Data Plate application and upload it to the device. Dynamic IP addresses are not visible in DDP.



This Ethernet connection does not have a dedicated web interface. All settings are configured via PC software or the Digital Data Plate application. However, you can confirm the viability of the Ethernet connection by entering the IP address in a web browser.

To test the Ethernet configuration:

1. Verify the IP address of the MC Synergy with the Ethernet option board installed. Tap INC and monitor the scroll of system status readings until IP appears. If a STATIC IP is in use, the IP address must be preconfigured in PC software or the Digital Data Plate app and uploaded to the device for it to display in the readout.
2. Enter the IP address in a web browser.
3. If the Ethernet connection is valid, this confirmation screen will appear in the web browser.



MC Synergy Ethernet Option	sensia
<p>✓ If you have reached this page, then the MC-Synergy Ethernet Option is functioning properly.</p> <p>The MC Synergy Ethernet Option supports Modbus TCP and Modbus Over TCP. For the complete list of register definitions refer to the protocol section of the MC Synergy user manual.</p> <p>The MC Synergy can be configured through the front panel, the PC Interface Software, and via Modbus registers. The PC Software and user manuals are available on our website www.sensiaglobal.com.</p>	
<p>For technical support:</p> <p>Email: info@sensiaglobal.com Website: https://www.sensiaglobal.com/Technical-Support Phone: 1-866-7 SENSIA (1-866-773-6742) sensiaglobal.com</p>	

ENABLE/RESET BLUETOOTH COMMUNICATION

The MC Synergy's Bluetooth compatibility allows you to connect and configure your device from a mobile phone or tablet.

From this menu, you can enable or disable the Bluetooth module, create an optional security code for access to device pairing, or reset the Bluetooth module.

When security is enabled with a passcode entry, you will be prompted for the pass code when pairing. See [Connect to MC Synergy via Bluetooth, page 69](#), for pairing instructions.

If you change the Bluetooth pass code, you must clear existing Bluetooth MC Synergy connections from your mobile device before attempting to reconnect/re-pair with the device. To clear existing Bluetooth connections, select the MC Synergy from the Bluetooth settings of the mobile device and select "Forget This Device."

Should the MC Synergy fail to pair with a phone or tablet, a Bluetooth reset command allows you to clear the settings and restart the pairing process. See step 9 below. For additional information, refer to [Bluetooth Application, page 18](#).

To enable and configure Bluetooth communications:

1. Tap MENU.
2. Use INC to advance to the Bluetooth Configuration menu.
3. Tap ENTER to enter the menu.
4. Use INC to enable or disable the Bluetooth functionality.
5. Tap ENTER to save and continue to the passcode (P-CODE) selection.
6. If a passcode is desired, use INC to change the value for the rightmost digit.
If a passcode is not desired, leave the all-zero code unchanged and skip to step 8.
7. Use STEP to go to the next digit and repeat steps 6 and 7 to complete the passcode entry.
8. Tap ENTER to save the selection and continue to the Bluetooth reset menu option.
9. Use INC to toggle YES (reset the Bluetooth module) or NO (skip reset).
If a reset is not desired, skip this step and proceed to step 10.



10. Tap ENTER to execute the selected action. **If resetting the module, wait until BT RESETTING disappears from the LCD and DONE appears on the top line. (CLEAR PHONE PAIRING will scroll across the bottom line of the LCD.)**

ENTER



See [Connect to MC Synergy via Bluetooth](#) below for instructions on connecting to an MC Synergy using the Digital Data Plate app installed on your mobile phone or tablet.

CONNECT TO MC SYNERGY VIA BLUETOOTH

A Bluetooth connection allows you to connect to the MC Synergy device with fewer button presses and is especially useful if the configuration lock is enabled to restrict access to the keypad configuration menus.

To access an MC Synergy totalizer from your mobile phone or tablet:

1. Install the Digital Data Plate app from your app store on your phone or tablet (both IOS and Android systems are supported).
2. Enable Bluetooth on your phone or tablet.
3. Enable Bluetooth on the MC Synergy device as described in [Enable/Reset Bluetooth Communication](#), page 68.
4. Make sure the Digital Data Plate app is installed on your smart phone or tablet, and your app is open when performing this procedure.

To connect to the MC Synergy using the Digital Data Plate app:

1. Tap STEP.
2. At the Enter for Bluetooth prompt, tap ENTER. A Bluetooth ID number with the prefix “nF” (named for the brand NUFLO) will appear in the LCD. The MC Synergy is now discoverable by other devices.
3. When “PA” appears on the LCD, switch your attention to the Digital Data Plate app on your phone or tablet and select “Connect to Device,” then “Scan for Devices.”
4. When the “nF” Bluetooth ID appears, select it and tap Confirm at the prompt.
5. Tap Pair at the Bluetooth Pairing Request prompt. If a passcode was entered during Bluetooth configuration, you will be asked to enter it in this dialog.

STEP

ENTER



CONFIGURE INPUT TYPE, SENSITIVITY AND METER KIT ALARM

The Input menu allows you to configure inputs, change input sensitivity, and manage an alarm for meter kit replacement. The flowmeter signal can be obtained from a magnetic pickup, a digital pulse input, or a contact closure input.

SENSITIVITY MEASUREMENT

Input sensitivity is measured in millivolts (mV) peak-to-peak and is the threshold value at which the circuitry responds to a signal.

- If the input signal is less than this value, the MC Synergy EXP Totalizer will treat the input as electrical noise and not count the electrical pulses as a valid turbine meter signal.
- If the input signal is equal to or greater than this value, the electrical pulses received at the input will be counted.

Care must be taken to ensure that the input sensitivity is high enough to reject any electrical noise on the signal line, but not so high that flowmeter pulses are missed.

When the input is provided by a turbine flowmeter, the input sensitivity may be set to low (~20 mV), medium (~50 mV), or high (~100 mV) .

If the input is a pulse from a pre-amplifier or other device (rather than directly from a turbine flowmeter), change the Pulse Input Type setting to "Digital Pulse Input."

See [page 43](#) and [page 44](#) for input wiring diagrams.

METER KIT ALARM

The MC Synergy accumulates the flowing time of the meter and provides an alarm to remind you to replace your meter internals when the actual total flowing time reaches a user-specified max flowing time. By default, the Replace Meter Kit alarm period is set to 10 years. Sensia recommends resetting this alarm period when a new meter or a new set of meter internals is installed. Meter life will vary with operating conditions. If you replaced your previous meter kit after 2 years of use, then 2 years is likely a reasonable period for the alarm setting.

The Replace Meter alarm period (years) can be changed in the PC software (Configure Device tab>K-Factor Entry). The configurable alarm period range is 1 day to 10 years.

To configure the input type, sensitivity and meter kit alarm settings from the keypad:

1. Tap MENU.
2. Use INC to advance to the Input menu.
3. Tap ENTER to enter the menu.
4. Tap INC to advance to the appropriate input mode setting:
 - For magnetic pick-up: Turbine Low (tur Lo, as shown), Turbine Medium, or Turbine High
 - Digital
 - Contact
5. Tap ENTER to save the selection and continue.

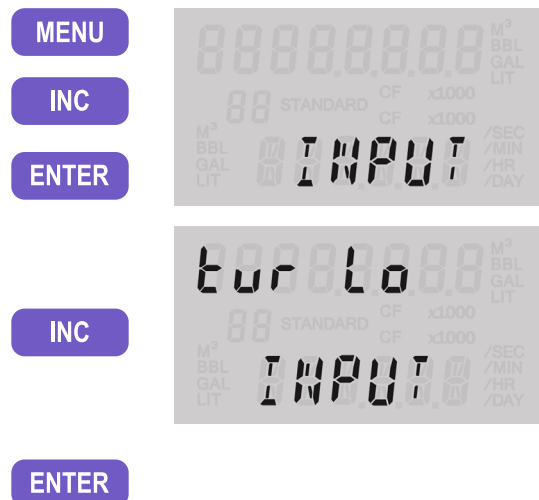

6. Tap INC to toggle actions for meter kit replacement:
 - Choose LEAVE to retain existing replacement alarm settings and exit the Input Configuration Menu.
 - Choose REPLACE if the replacement alarm needs to be reset (recommended when replacing a meter kit).

7. Tap ENTER to reset the Replace Meter Kit alarm. User-specified alarm periods must be entered via the Digital Data Plate app or the PC software (Configure Device>K-Factor Entry).

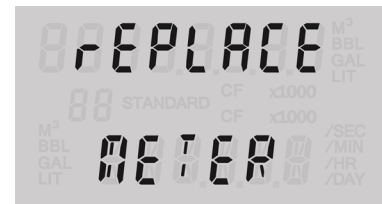

MONITOR METER KIT LIFE

When the meter kit is replaced and the Replace Meter Kit alarm is reset in the totalizer, the Internals Kit Run Time value visible in the PC software is cleared to zero. When a flow input is detected, the alarm counter begins counting the days of operation. When the total count of days of operation equals the configured kit alarm period, the alarm will activate as a reminder to replace the meter kit. See [Turbine Alarms, page 24](#), and the PC software manual for more information.

A meter kit's run time can be observed via the PC software (Device Status tab>Alarms Status>Turbine Alarms), as shown in [Figure 3.9, page 72](#).

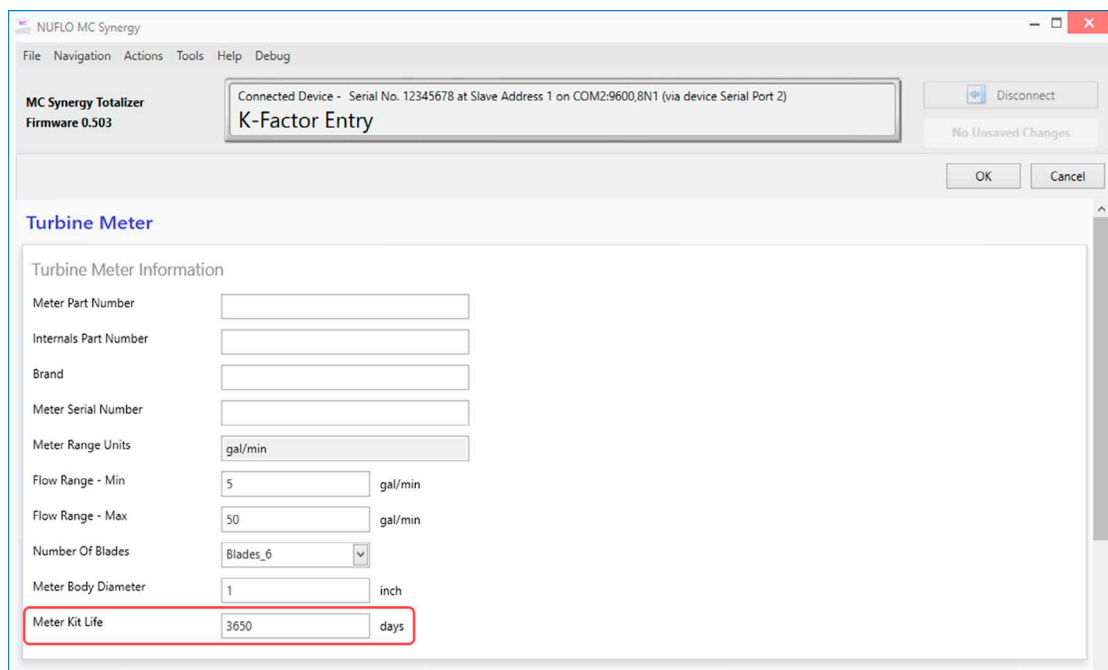

Figure 3.8—Configuration of meter kit replacement alarm

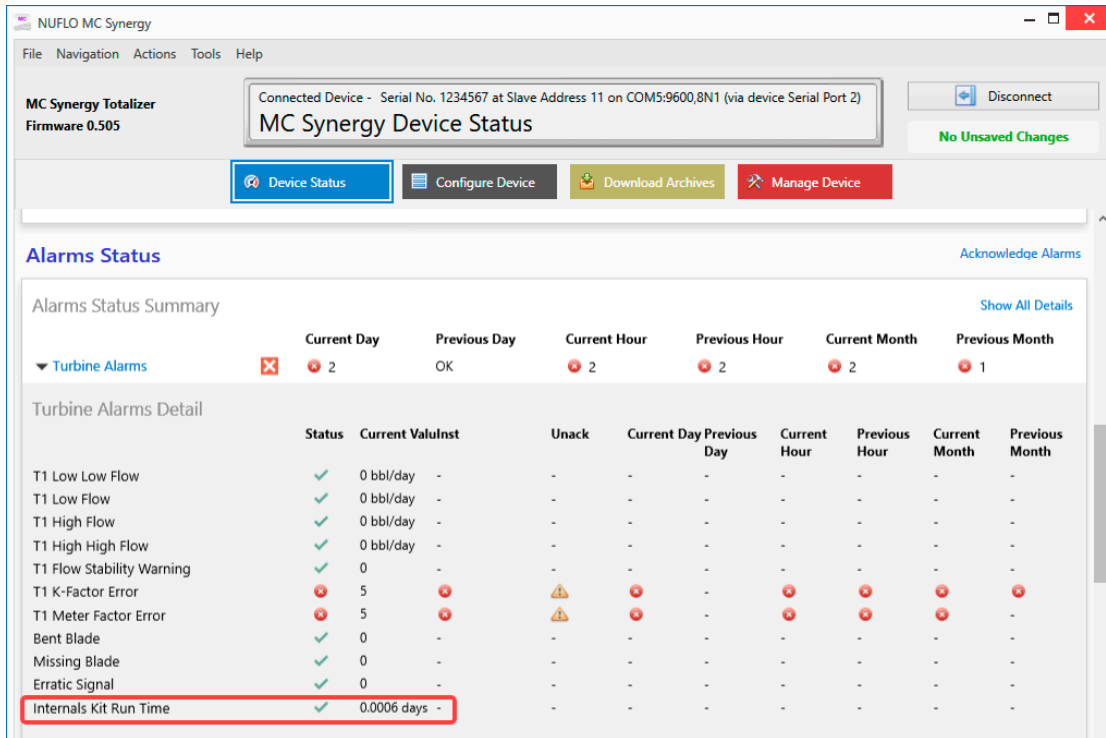

Figure 3.9—The Internals Kit Run Time value is zeroed when a new kit is installed and the meter alarm is reset.

CONFIGURE THE PULSE OUTPUT

To reduce current consumption, disable the pulse output feature of the MC Synergy EXP Totalizer when the pulse output is not needed.

When the pulse output feature is enabled, you will be prompted to enter a scale factor, which is the volume increment that will cause a pulse output to occur.

If the pulse output is configured via PC software, you can also specify a pulse length (width) in milliseconds (ms). This parameter is configurable only with the PC software or the Digital Data Plate application. See Section 4 for more information.

When you configure a pulse output in the PC software, you have two additional output modes to choose from that are not available in the keypad menu: Status Output and Modbus Register Control. When one of these modes is selected, the bottom row of the local display will contain the scrolling message, "Software Configured."

See [Digital Output, page 44](#) for instructions on installing and wiring the pulse output feature.

To configure the pulse output via the keypad:

1. Tap MENU.
2. Use INC to advance to the Output Configuration menu.
3. Tap ENTER to enter the menu.



- Use INC to advance to the desired output mode for Digital Output 1:

- Disabled
- Precise
- Scaled
- Amplify

If a digital output is not required, select DISABLED.



- Tap ENTER to save the selection and continue.



- If Precise mode is selected, tap INC or STEP to select a scalar value from the available options (1 through 1/10,000).
If Scaled mode is selected, you can enter a precise scalar value by tapping STEP to select a digit or decimal position to be changed and tapping INC to change the decimal position or value of a selected digit.



- Tap ENTER to save the scalar and continue.



- Repeat steps 4 through 7 to configure the desired output mode for Digital Output 2.

LOAD DEFAULT VALUES

Loading the default configuration is useful if you wish to either reset the configuration of a device for security purposes, the device has moved to a new location, or the device requires debugging. Default settings for the device may be restored via the keypad or PC software.

PC software provides the greatest control over default loads, allowing you to select which types of settings you want to return to default values: general configuration, communications, and/or calibration settings.

The Load Defaults function in the keypad menu restores default values to general configuration settings, but not communications and calibration settings.

Re-configuration and re-calibration of the device may be required after performing this action.

To load default settings via the keypad:

- Tap MENU.
- Use INC to advance to the Load Defaults menu.
- Tap ENTER to enter the menu.
- Tap ENTER to load all default settings and exit the menu.



ENTER METER FACTORS

The meter factor is used to adjust the effective K-factor when the meter ages. Instead of re-entering the K-factor, you may simply enter in a meter factor which will be multiplied by the K-factor to correct it. The Meter Factor is specific to the turbine meter being used. It can be calibrated as a single linear value over all frequencies, or as a multipoint factor with up to 12 calibration points over a range of frequency values using linear interpolation between points. The meter factor menu may be entered directly via the KFACT button.

LINEAR METER FACTOR

A Linear Meter Factor can be entered into the MC Synergy device via the keypad, via the Digital Data Plate app, or via PC software. Refer to the MC Synergy Software User Manual for instructions for entering a meter factor via the software application.

To enter a linear meter factor via the keypad:

1. Press and hold KFACT until the Meter Factor menu (M-FACT) appears. The upper row of the LCD will display a flashing NO by default.
2. Tap INC to toggle **YES** to select the Meter Factor Configuration Menu.
3. Tap ENTER to save and continue.
4. If **LINEAR** is not displayed in the LCD, tap INC to toggle to **LINEAR** as your meter factor type.
5. Tap ENTER to save and continue.
6. With the decimal blinking, use INC to cycle through available decimal positions and make a selection.
7. Tap STEP to switch to the numeric value entry. The rightmost digit will flash to identify the digit selected for change.
8. Use INC to change the value of the digit. If no change is desired, proceed to step 9.

KFACT



INC



ENTER

INC



ENTER

INC



STEP



INC

9. Repeat the STEP and INC sequence to enter all digits of the meter factor.
10. Tap ENTER to save and exit the menu.
11. The LCD will display a confirmation message "SAVING."

ENTER



MULTI-POINT METER FACTOR

Multi-point meter factors can be entered into the MC Synergy totalizer via the keypad or PC software. Refer to the MC Synergy Software User Manual for instructions for entering a meter factor via the software application.

To enter a multi-point meter factor via the keypad,:

1. Press and hold KFACT until the Meter Factor menu (M-FACT) appears. The upper row of the LCD will display a flashing NO by default.
2. Tap INC to toggle YES to select the Meter Factor Configuration Menu.
3. Tap ENTER to save and continue.
4. If 12-PNT is not displayed in the LCD, tap INC to toggle to 12-PNT as your meter factor type.
5. Tap ENTER to save and continue. ("Edit" and "Multi" will display momentarily on the LCD.)
6. While the top row of the LCD is flashing, use INC to select the number of calibration points desired (any number from 2 to 12).
7. Press ENTER to save and continue.
8. A flash screen will appear momentarily to show the position of the frequency (bottom row of LCD) and correlating meter factor (top row). A two-digit index number (starting with "01") uniquely identifies each calibration point entered.

KFACT



INC



ENTER

INC



ENTER

INC



ENTER



When the rightmost digit in the bottom row begins flashing, proceed to step 9 to enter the frequency value corresponding with calibration point 1.

9. Use INC to cycle through values from 0 to 9 and select the proper value for the selected digit.
10. Use STEP to select the next digit to the left.
11. Use INC to change the value of the selected digit.
12. Repeat the STEP + INC sequence to enter the rest of the digits in the frequency value.
13. When all frequency digits are entered, tap STEP to move the flashing digit selector to the DECIMAL in the top row of the LCD (meter factor).
14. With the decimal blinking, use INC to cycle through available decimal positions and make a selection.
15. Tap STEP to switch to the numeric value entry. The rightmost digit will flash to identify the digit selected for change.
16. Use INC to change the value of the digit.
17. Repeat the STEP + INC sequence to enter the rest of the digits in the meter factor.
18. Tap ENTER to save the selections for calibration point 01 and advance the menu to the next calibration point. The indicator will iterate sequentially to 02, 03, etc.
19. When the last calibration point is entered and saved, the LCD will display a confirmation message "SAVING."

INC

STEP

INC



STEP

INC



STEP

INC

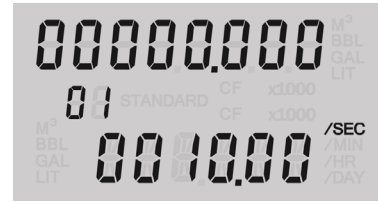

ENTER



ENTER K-FACTORS

The K-factor is used to represent the ratio between the number of pulses and a unit of volume. This is specific to the turbine meter being used. It can be calibrated as a single linear value over all frequencies, or as a multipoint factor with up to 12 calibration points over a range of frequency values using linear interpolation between points.

LINEAR K-FACTOR

A linear K-factor can be entered into the MC Synergy totalizer via the keypad, the Digital Data Plate app, or the PC software. Refer to the MC Synergy Software User Manual and MC Synergy Quick Start Guide for instructions on entering a K-factor via the software application or Digital Data Plate application, respectively.

Entry of a linear K-factor requires the user to specify the K-factor value, decimal precision, and volume unit.

To enter a Linear K-factor via the keypad:

Note When the volume is to be expressed in barrels (BBL), gallons (GAL), liters (LIT), cubic meters (M3), or cubic feet (CF), and the flow rate is to be expressed in barrels, gallons, liters, cubic meters or cubic feet per day, per hour, per minute, or per second, the MC Synergy EXP Totalizer calculates the divisor automatically; only the turbine meter calibration factor is required.

When the volume is to be expressed in a unit other than the pre-programmed units listed above, the units must be configured via the Digital Data Plate app or the PC software.

1. Press and hold KFACT until the Meter Factor menu (M-FACT) appears. In the top row, "no" will flash.

If you see a numeric display instead, you released the KFACT button too soon. Tap MENU to exit the numeric display and repeat step 1.

KFACT



2. Tap ENTER to bypass the meter factor menu and continue on to the K-factor Type menu. Linear will display by default.

ENTER



3. Tap ENTER to save and continue. The unit indicator will flash in the top row of the LCD.

ENTER



4. Use INC to cycle through available K-factor units and make a selection.

INC



5. Tap STEP to switch to the decimal setting.

STEP

6. Use INC to cycle through available decimal positions and make a selection.

INC

7. Tap STEP to switch to the numeric value entry. The rightmost digit will flash to identify the digit selected for change.
8. Use INC to cycle through values from 0 to 9 and select the proper value for the selected digit.
9. Tap STEP to select the next digit to the left.
10. Repeat steps 8 and 9 to enter all digits of the K-factor.
11. Tap ENTER to save and store the Linear K-factor and exit the menu.
12. The LCD will display a confirmation message "SAVING."

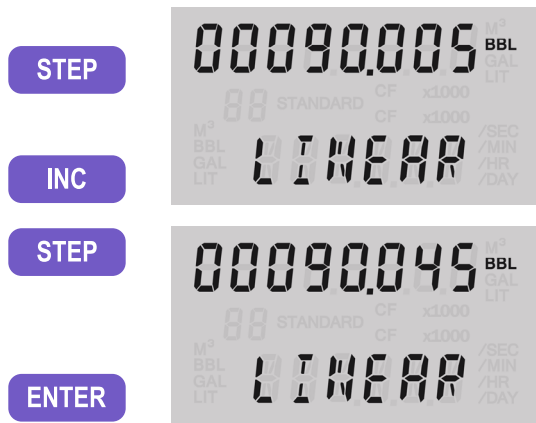

MULTI-POINT K-FACTOR

A multi-point K-factor can be entered into the MC Synergy device via the keypad or PC software, or uploaded via a QR code scan using the Digital Data Plate app (see the MC Synergy QuickStart Guide for details).

Refer to the MC Synergy Software User Manual for instructions for entering a multi-point K-factor via the PC software. The device will use linear interpolation between points. Up to 12 calibration points over a range of frequency values may be entered.

After selecting a multi-point K-factor, the user will then be asked to specify the number of factors that will be implemented. This number may be set to be 2, or as many as 12 factors which will be calibrated for different frequencies.

The units for all the factors must be uniform. In selecting the desired units, it is often useful to consider the pulses per set volume unit generated by the turbine flowmeter being used. Users must specify the value and decimal precision of the frequency, as well as the value and decimal precision of the K-factor.

Note When the volume is to be expressed in barrels (BBL), gallons (GAL), liters (LIT), cubic meters (M3), or cubic feet (CF), and the flow rate is to be expressed in barrels, gallons, liters, cubic meters or cubic feet per day, per hour, per minute, or per second, the MC Synergy EXP Totalizer calculates the divisor automatically; only the turbine meter calibration factor is required.

When the volume is to be expressed in a unit other than the pre-programmed units listed above, the entry must be done via the Digital Data Plate app or the PC software.

1. Press and hold KFACT until the Meter Factor menu (M-FACT) appears. In the top row, "no" will flash.

If you see a numeric display instead, you released the KFACT button too soon. Tap MENU to exit the numeric display and repeat step 1.
2. Tap ENTER to bypass the meter factor menu and continue on to the K-factor Type menu. Linear will display by default.



3. Tap INC to toggle the K-factor type selection to **12-PNT**.



4. Tap ENTER to save and continue. (“Edit” and “Multi” will display momentarily on the LCD.)



5. While the top row of the LCD is flashing, use INC to select the number of calibration points desired (any number from 2 to 12).



6. Tap ENTER to save and continue.



7. Use INC to choose the “pulses per” frequency unit. Choose from pulses per gallon, per barrel, per cubic meter, per cubic feet, or per liter.



8. A flash screen will appear momentarily to show the location of frequency (bottom row) and correlating K-factor (top row). A two-digit index number (starting with “01”) uniquely identifies each calibration point entered.



When the rightmost digit in the bottom row begins flashing, proceed to step 9 to enter the frequency value corresponding with calibration point 1.

9. Use INC to cycle through values from 0 to 9 and select the proper value for the selected digit in the frequency value.



10. Tap STEP to select the next digit to the left.



11. Use INC to change the value of the selected digit.



12. Repeat the STEP + INC sequence to enter the rest of the digits in the frequency value.



13. When all frequency digits are entered, tap STEP to move the flashing digit selector to the DECIMAL in the top row of the LCD (K-factor).



14. With the decimal blinking, use INC to cycle through available decimal positions and make a selection (tenths, hundredths, thousandths, or ten-thousandths).



15. Tap STEP to switch to the numeric value entry. The rightmost digit will flash to identify the digit selected for change.
16. Use INC to cycle through values from 0 to 9 and select the proper value for the selected digit.
17. Tap STEP to select the next digit to the left.
18. Use INC to select the proper value for the selected digit.
19. Repeat steps 17 and 18 to enter all digits of the K-factor.
20. Tap ENTER to save the selections for calibration point 01 and advance the menu to the next calibration point. The indicator will iterate sequentially to 02, 03, etc.
21. When the last calibration point is entered and saved, the LCD will display a confirmation message "SAVING."

STEP



INC

STEP

INC



ENTER

Section 4: Maintenance

The MC Synergy™ EXP Totalizer is designed to provide many years of service with minimal maintenance. Batteries require periodic replacement, and battery life depends on whether battery power is the primary or secondary power source.

All configuration settings are stored in nonvolatile memory; therefore, configuration settings will not be lost in the event of battery failure.

The circuit assembly may also require replacement over the life of the instrument. Procedures are provided in this section.

LITHIUM BATTERY REPLACEMENT

The MC Synergy EXP Totalizer optionally uses two lithium batteries, each with a life expectancy of approximately 2 years. Due to the flat discharge characteristics of the lithium battery, it is difficult to determine how much life remains in a battery at any given time. The MC Synergy calculates the energy dissipated by electronics from the connected batteries and reports the remaining capacity to help predict the need for battery replacement. Under normal operating conditions, Sensia recommends replacement of batteries every two years.

**WARNING**

To prevent ignition of hazardous atmospheres, do not remove the cover while circuits are alive. **DO NOT OPEN WHEN AN EXPLOSIVE GAS ATMOSPHERE IS PRESENT.** Under normal conditions, the MC Synergy EXP Totalizer poses no hazard when opened in a safe area.

**WARNING**

Replace only with the Sensia 3.6 VDC Lithium Battery Assembly, part number 100005111 (CEC/NEC and IEC/ATEX approved).

**WARNING**

The lithium batteries that power the MC Synergy EXP Totalizer are sealed units. However, should a lithium battery develop a leak, toxic fumes could escape upon opening the enclosure. Ensure that the instrument is in a well-ventilated area before opening the enclosure to avoid breathing fumes trapped inside the enclosure. Exercise caution in handling and disposing of spent or damaged batteries.

See additional information on lithium batteries in [Appendix B—Lithium Battery Information, page B-1](#) of this manual.

The lithium battery is secured inside the enclosure by a hook and loop strap and connected to the BAT1 and/ or BAT2 connector near the top of the circuit assembly.

Important If two lithium batteries are in use, replace them one at a time to prevent the unit from losing power and ensure no loss of data during replacement.

To replace a lithium battery in the MC Synergy EXP Totalizer, perform the following steps:

1. Unscrew the cover of the enclosure counter-clockwise until it separates from the main body of the enclosure.
2. Using a small standard blade screwdriver, remove the two #4-40 × 7/8" screws located to the right and left side of the display ([Figure 4.1, page 82](#)).



Figure 4.1—Removal of faceplate assembly

3. Lift the display assembly from the enclosure, making sure the circuit assembly does not contact the enclosure.
4. Loosen the battery retaining strap, disconnect the battery from the BAT1 (or BAT2) connector on the circuit assembly, and remove the battery from the enclosure (Figure 4.2). If there are two batteries, replace them one at a time to prevent any potential loss of measurements.

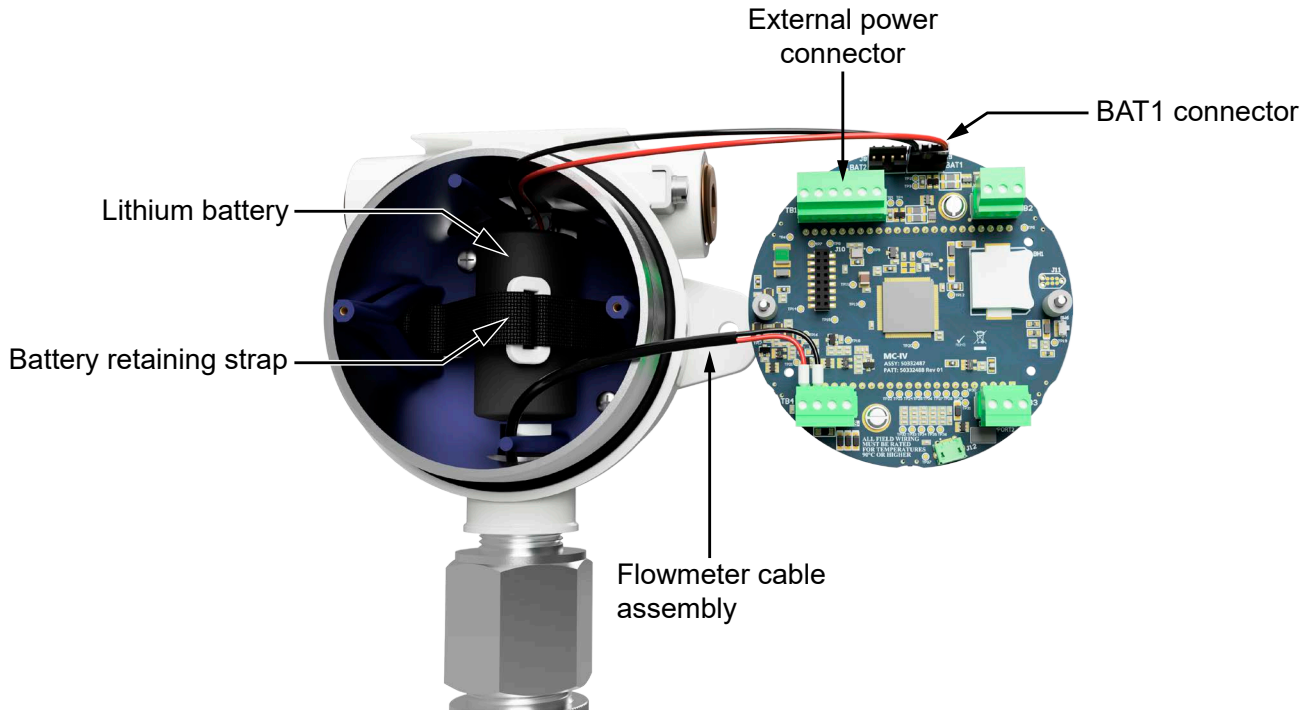

Figure 4.2—Removal/replacement of lithium battery

5. Install a new battery in the enclosure in the same position as the original battery, and secure the battery retaining strap tightly around the battery.
6. Connect the replacement battery to the BAT1 (or BAT2) connector.
7. Place the circuit assembly over the standoffs and fasten with the two #4-40 × 7/8" screws, ensuring that all connector wiring is inside the enclosure.
8. Replace the enclosure cover, threading it onto the enclosure in a clockwise direction.

ALKALINE BATTERY REPLACEMENT

The alkaline battery pack will require periodic replacement. If the LCD is dimming, replace the battery pack without delay.



WARNING

To prevent ignition of hazardous atmospheres, do not remove the cover while circuits are alive. **DO NOT OPEN WHEN AN EXPLOSIVE GAS ATMOSPHERE IS PRESENT.** Under normal conditions, the MC Synergy EXP Totalizer poses no hazard when opened in a safe area.

The shrink-wrapped alkaline battery pack is secured inside the MC Synergy EXP Totalizer enclosure by a hook and loop strap and connected to a connector (BAT1) near the top of the circuit assembly.

To replace the battery pack, perform the following steps:

1. Unscrew the cover of the enclosure counter-clockwise until it separates from the main body of the enclosure.
2. Using a small standard blade screwdriver, remove the two #4-40 × 7/8" screws located to the right and left side of the display (Figure 4.3).



Figure 4.3—Removal of faceplate assembly

3. Lift the display assembly from the enclosure.
4. Loosen the battery retaining strap, disconnect it from the BAT1 connector on the circuit assembly, and remove the battery from the enclosure (Figure 4.4, page 84).

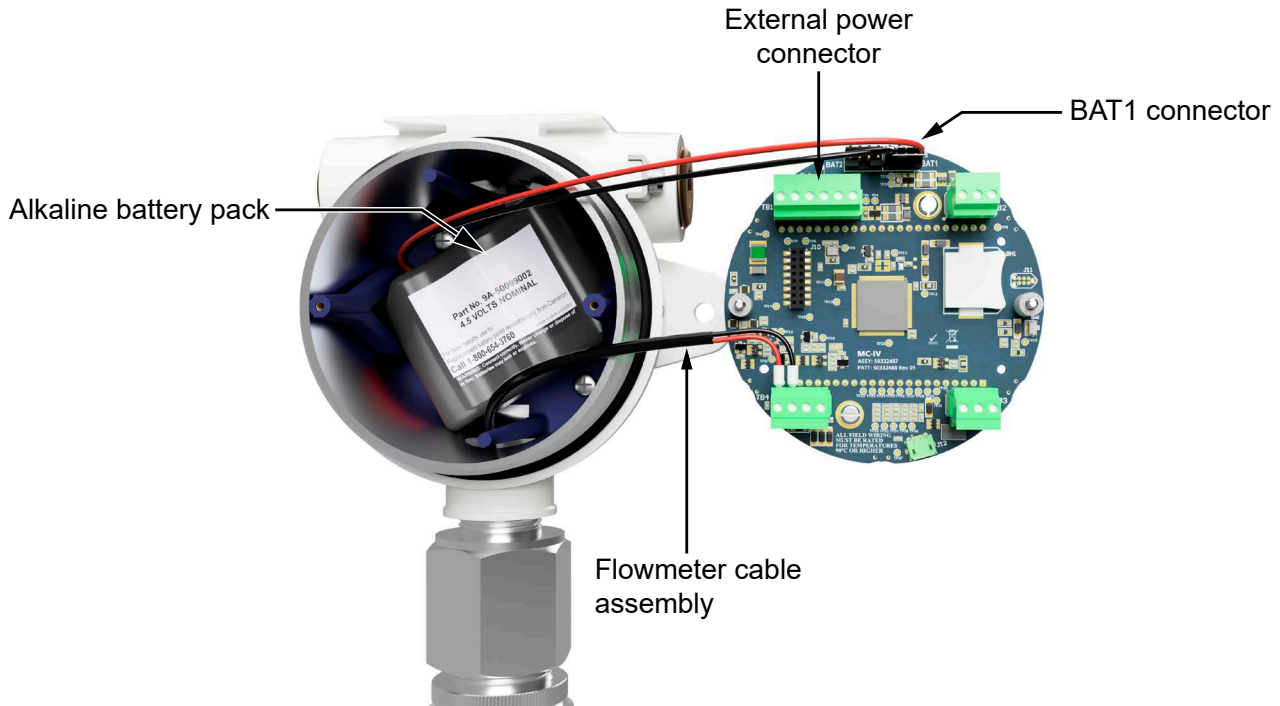

Figure 4.4—Removal/replacement of alkaline battery pack

5. Install the new shrink-wrapped battery pack in the same position as the original battery pack as shown in [Figure 4.4](#), and secure the battery retaining strap to hold the pack tightly in place.
6. Connect the replacement battery pack to the BAT1 connector.
7. Place the circuit assembly over the standoffs and fasten with the two #4-40 × 7/8" screws, ensuring that all connector wiring is inside the enclosure.
8. Replace the enclosure cover, threading it onto the enclosure in a clockwise direction.

CIRCUIT ASSEMBLY REPLACEMENT



WARNING

To prevent ignition of hazardous atmospheres, do not remove the cover while circuits are alive. **DO NOT OPEN WHEN AN EXPLOSIVE GAS ATMOSPHERE IS PRESENT.** Under normal conditions, the MC Synergy EXP Totalizer poses no hazard when opened in a safe area.

Important Static electricity can damage a circuit board. Handle new boards only by their edges, and use proper anti-static techniques (such as wearing anti-static wrist strap or touching metal to establish an earth ground) prior to handling a board.

Important If possible, record the accumulated total and all configuration settings before replacing the circuit board. This information can be recorded by hand or captured by saving a configuration file that can be reloaded into the unit after the circuit board is replaced.

To replace the circuit assembly, perform the following steps:

1. Unscrew the cover of the enclosure counter-clockwise until it separates from the main body of the enclosure.

- Using a small standard blade screwdriver, remove the two #4-40 × 7/8" screws located to the right and left side of the display (Figure 4.5).



Figure 4.5—Removal of faceplate assembly

- Lift the display assembly from the enclosure.
- Record the locations of all cable connections to the circuit assembly.
- Unplug all of the terminal blocks from the display, in order to free up the display.
- Unplug the battery cable from connector BAT1 (and BAT2 if two batteries) on the circuit assembly.
- Remove the two #4-40 × 5/16" screws fastening the circuit assembly to the display assembly (Figure 4.6).

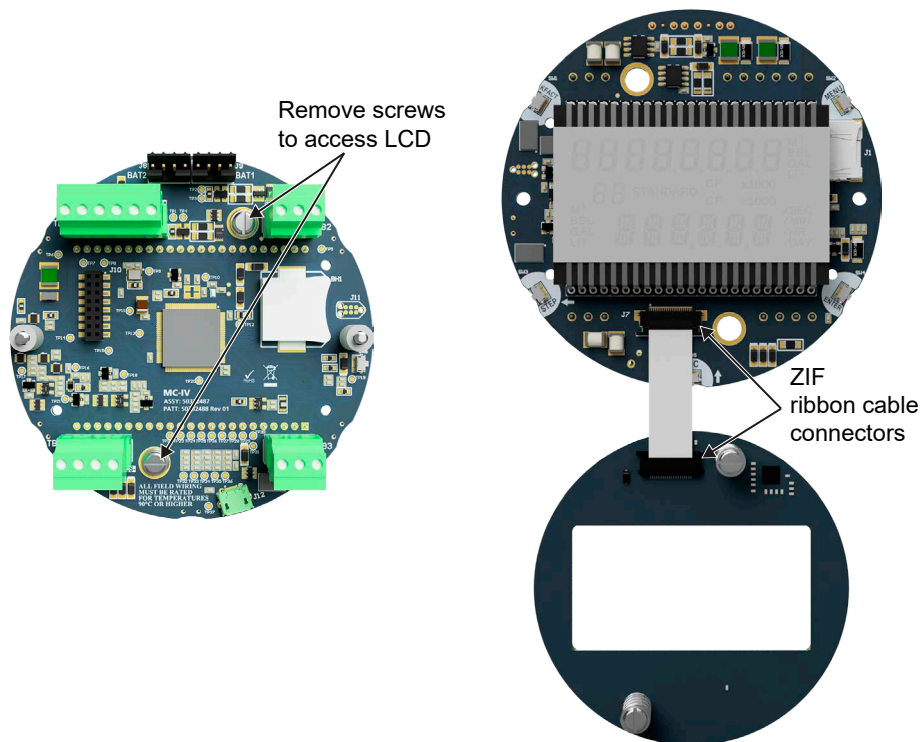

Figure 4.6—Disassembly of circuit board assembly

8. Disconnect the ribbon cable from the ZIF ribbon cable connector on the button side of the circuit assembly as follows:
 - a. Pull both black tabs on the ZIF ribbon cable connector to the unlock position.
 - b. Gently pull the cable free of the connector.
9. Remove the original circuit assembly from the enclosure.
10. Connect the ribbon cable to the ZIF ribbon cable connector on the button side of the circuit assembly as follows:
 - a. Insert the end of the ribbon cable into the ZIF ribbon cable connector.
 - b. Push both black tabs on the ZIF ribbon cable connector into the lock position.
11. Mount the circuit assembly to the buttons with the two #4-40 × 5/16" screws.
12. Reconnect the battery cable to BAT1 (and BAT2 if two batteries) on the circuit assembly.
13. Re-plug in all of the terminal blocks.
14. Mount the display assembly to the enclosure with the two #4-40 × 7/8" screws.
15. Recalibrate the MC Synergy EXP Totalizer, then replace the enclosure cover.
16. Re-establish power to the peripheral circuitry.

MC SYNERGY SPARE PARTS (CEC/NEC)



CAUTION

EXPLOSION HAZARD—SUBSTITUTION OF COMPONENTS MAY IMPAIR SUITABILITY FOR CLASS I, DIVISION 1 IN THE UNITED STATES AND CANADA. USE OF SPARE PARTS OTHER THAN THOSE IDENTIFIED BY SENSIA VOIDS CSA CERTIFICATION. SENSIA BEARS NO LEGAL RESPONSIBILITY FOR THE PERFORMANCE OF A PRODUCT THAT HAS BEEN SERVICED OR REPAIRED WITH PARTS THAT ARE NOT AUTHORIZED BY SENSIA.

TABLE 1.8—SPARE PARTS (CEC/NEC)

Part Number	Description
50382868	Keypad Switchplate Assembly Kit, includes ribbon cable, springs, and mounting screws - overlay does not include HART symbol
50382869	Keypad Switchplate Assembly Kit, includes ribbon cable, springs, and mounting screws - overlay includes HART symbol
50382921	Main Board Circuit Assembly Kit, includes coin cell battery, ribbon cable, springs, and screws
9A-90017002	Signal Cable - 18", for direct mount units
9A-100005111	Lithium Battery, Single D Cell, 3.6 VDC (MC Synergy can accommodate up to 2 batteries)
9A-50099002	Battery Pack, Alkaline (3 "C" Cells), Shrinkwrapped
9A-100002605	Desiccant
50382456	Expansion Board Kit, Analog Output/HART (includes standoffs and screws)
50382457	Expansion Board Kit, Ethernet (includes standoffs and screws)
9A-30054001	Assembly, Reset Switch, Explosion-Proof, CEC/NEC
2295524-01	Local Communications Adapter in Sealed Conduit (USB), CEC/NEC (driver required)
9A-90017004	Local Communications Adapter in Sealed Conduit (RS-485), CEC/NEC
9A-50053009	IS Barrier, RS-485, CEC/NEC Class I, Div 1 & 2, Grps A, B, C, D; and, ATEX Class 1, Zone 1 & 2, IIC, IIB, IIA
9A-100017622	Union, 1-in.
9A-99064006	Pipe Plug, Explosion-Proof, 3/4"-14 NPT, Hex Socket, Brass

TABLE 1.8—SPARE PARTS (CEC/NEC)

Part Number	Description
9A-99064008	Pipe Plug, Explosion-Proof, 3/4"-14 NPT, Hex Socket, Stainless Steel
9A-30028004	Remote Mount Pole Mount Kit, Plated Steel
9A-30028005	Remote Mount Pole Kit, Stainless Steel
2295669-01	Reducer to mount to BARTON Turbine Meters, 3/4" FNPT X 1" MNPT
9A-100005137	Magnetic Pickup Extension Adapter, 1"M x 1"F, 3.00" Long
9A-0027-9055T	Communications Cable, USB Type A (at PC) to USB Type B (at MC Synergy), 15 feet long
2296650-01	Communications Converter Assembly, RS-485 (at MC Synergy) to USB Type B, with 20 ft. Cable. <i>Requires a USB Type A/B communications cable to connect to a standard laptop port. See Sensia Part No. 9A-0027-9055T.</i>
9A-101283116	Communications Converter Assembly, RS-485 (at MC Synergy) to RS-232 (at PC), with 20 ft. Cable
50274206-10	CEC/NEC EXP Terminal Housing, Cable, and Hardware to attach Turbine Meter to Remote Mounted MC Synergy, 10 foot
50274206-20	CEC/NEC EXP Terminal Housing, Cable, and Hardware to attach Turbine Meter to Remote Mounted MC Synergy, 20 foot
50274206-25	CEC/NEC EXP Terminal Housing, Cable, and Hardware to attach Turbine Meter to Remote Mounted MC Synergy, 25 foot
50274206-50	CEC/NEC EXP Terminal Housing, Cable, and Hardware to attach Turbine Meter to Remote Mounted MC Synergy, 50 foot
77023596	Coin Cell Battery, Lithium, 3V, 12.5mm, BR-1225

MC SYNERGY SPARE PARTS (IEC/ATEX)**CAUTION**

EXPLOSION HAZARD—SUBSTITUTION OF COMPONENTS MAY IMPAIR SUITABILITY FOR ATEX AND IECEX APPROVALS. USE OF SPARE PARTS OTHER THAN THOSE IDENTIFIED BY SENSIA VOIDS ATEX/IECEX CERTIFICATION. SENSIA BEARS NO LEGAL RESPONSIBILITY FOR THE PERFORMANCE OF A PRODUCT THAT HAS BEEN SERVICED OR REPAIRED WITH PARTS THAT ARE NOT AUTHORIZED BY SENSIA.

TABLE 1.9—SPARE PARTS (IEC/ATEX)

Part Number	Description
50382868	Keypad Switchplate Assembly Kit, includes ribbon cable, springs, and mounting screws - overlay does not include HART symbol
50382869	Keypad Switchplate Assembly Kit, includes ribbon cable, springs, and mounting screws - overlay includes HART symbol
50382921	Main Board Circuit Assembly Kit, includes coin cell battery, ribbon cable, springs, and screws
9A-90017002	Signal Cable - 18", for direct mount units
9A-100005111	Lithium Battery, Single D Cell, 3.6 VDC (MC Synergy can accommodate up to 2 batteries)
9A-100002605	Desiccant
50382456	Expansion Board Kit, Analog Output/HART (includes standoffs and screws)
50382457	Expansion Board Kit, Ethernet (includes standoffs and screws)

TABLE 1.9—SPARE PARTS (IEC/ATEX)

Part Number	Description
9A-30025001	Tube, Standoff, Stainless Steel, for BARTON 7000 Series Turbine Meters, 1.18 in. Hex X 3.56 in. long with 3/4 in. NPT Male and Female Ends
9A-30025006	Tube, Standoff, Stainless Steel, for NUFLO Turbine Meters, 4.00 in. long with 3/4 in. NPT Male and 1 in. NPT Female Ends, ATEX
9A-30054002	Assembly, Reset Switch, Explosion-Proof, ATEX
9A-90017008	Communications Adapter in Sealed Conduit (RS-485) - ATEX
9A-50053009	IS Barrier, RS-485, CEC/NEC Class I, Div 1 & 2, Grps A, B, C, D; and, ATEX Class 1, Zone 1 & 2, IIC, IIB, IIA
9A-99064006	Pipe Plug, Explosion-Proof, 3/4"-14 NPT, Hex Socket, Brass
9A-99064008	Pipe Plug, Explosion-Proof, 3/4"-14 NPT, Hex Socket, Stainless Steel
9A-30028004	Remote Mount Pole Kit, Plated Steel
9A-30028005	Remote Mount Pole Kit, Stainless Steel
9A-0027-9055T	Communications Cable, USB Type A (at PC) to USB Type B (at MC Synergy), 15 feet long
2296650-01	Communications Converter Assembly, RS-485 (at MC Synergy) to USB Type B, with 20 ft. Cable. <i>Requires a USB Type A/B communications cable to connect to a standard laptop port. See Sensia Part No. 9A-0027-9055T.</i>
9A-101283116	Communications Converter Assembly, RS-485 (at MC Synergy) to RS-232 (at PC), with 20 ft. Cable
77023596	Coin Cell Battery, Lithium, 3V, 12.5mm, BR-1225

Appendix A—Hardware Options

EXPLOSION-PROOF RESET/CONTROL SWITCH

An external explosion-proof reset/control switch (Figure A.1) allows the user to reset the total, advance the display, clear unacknowledged alarms, create a partial record, and/or publish polling registers without removing the instrument cover or connecting the instrument to a laptop. The mode of operation can be configured from the PC software.

**CAUTION**

This switch is available in two models. The CSA-approved model has a stainless steel adapter, and the ATEX-approved model has a brass adapter.

The reset/control switch assembly mounts in either threaded conduit opening in the instrument housing.



Figure A.1—Explosion-proof reset/control switch (CSA-approved stainless steel adapter shown)

INSTALLATION

If the switch is ordered with an MC Synergy, it will be installed prior to shipment.

To add a switch to an existing MC Synergy, connect the leads to connector TB4 on the main circuit board ([Figure A.2, page A-2](#)).

OPERATION

To reset the volume total with an explosion-proof switch, press and hold the switch for at least 3 seconds, then release it.

Important Do not release the switch prematurely. The reset will fail if the switch is not pressed for a minimum of 3 seconds.

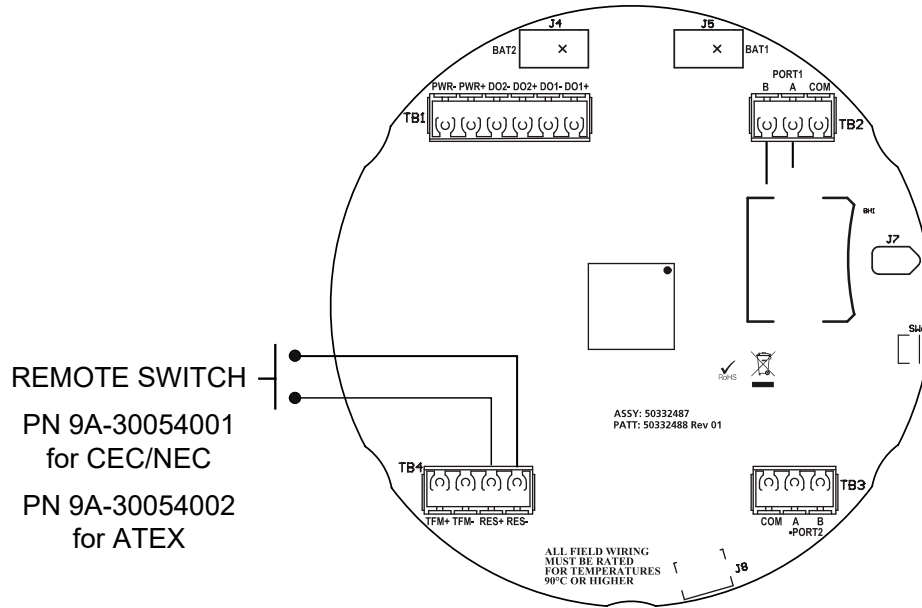

Figure A.2—Explosion-proof switch wiring

EXPLOSION-PROOF RS-485 COMMUNICATIONS ADAPTER

The explosion-proof communications adapter provides an RS-485 connection for connecting a laptop or PC to the instrument without removing the instrument cover. When the adapter is ordered with an MC Synergy EXP Totalizer, it is factory installed. The installed adapter is comprised of an RS-485 adapter socket, a blanking plug, and a union nut (Figure A.3). It may be relocated to either conduit opening in the instrument housing.

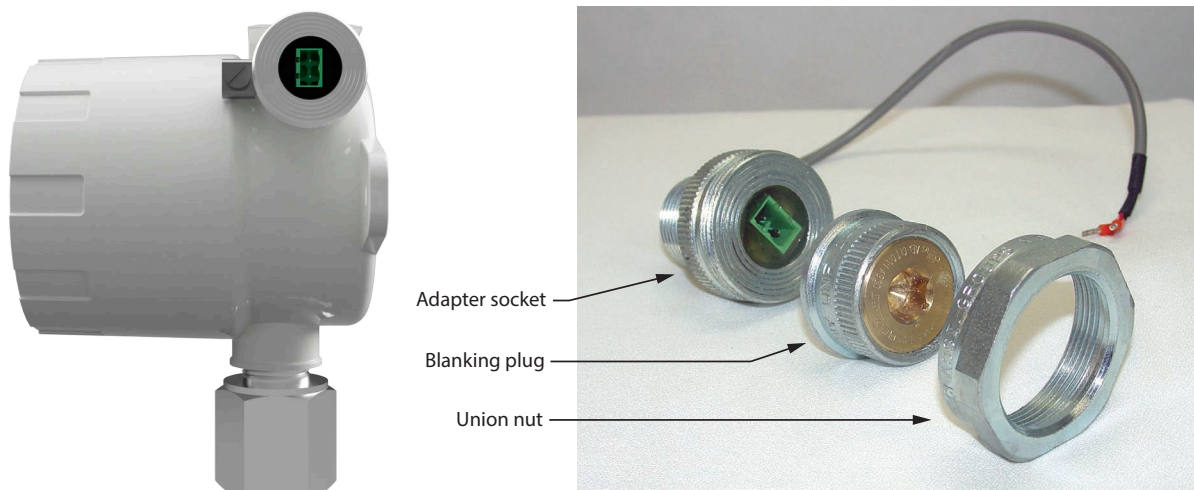

Figure A.3—Components of explosion-proof communications adapter

ASSEMBLY OF THE PLUG CONNECTOR

A plug connector that mates with the RS-485 adapter socket is shipped with the device (uninstalled). This plug connector should be wired to an RS-485 converter cable as shown in Figure A.4, and stored with the cable when the COM adapter is not in use.

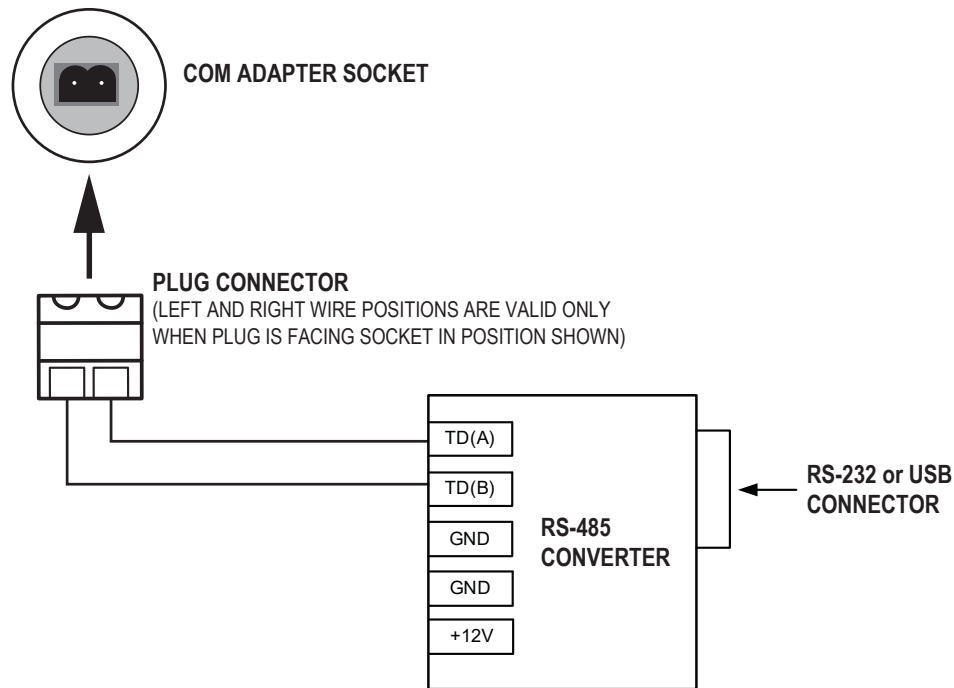

Figure A.4—Plug connector installation with user-supplied RS-485 converter (available from Sensia)

USER-SUPPLIED ACCESSORIES

An RS-485 to RS-232 converter cable (available from Sensia) is required for connecting the communications adapter to a PC or laptop. See [MC Synergy Spare Parts \(CEC/NEC\), page 86](#), and [MC Synergy Spare Parts \(IEC/ATEX\), page 87](#) for converter cable options.

CONNECTING TO THE COMMUNICATIONS ADAPTER

Take the following precautions when disassembling the communications adapter.



WARNING

When a hazardous area is present, ensure the union nut and blanking plug are properly fitted in the conduit opening. The explosion-proof rating applies only when the union nut and blanking plug are secured in place. When the union is broken, the device is no longer explosion-proof.



WARNING

Before disassembling the union nut and blanking plug, make sure the area is nonhazardous.

To connect a PC or laptop to the communications adapter, perform the following steps:

1. Unscrew the union nut to expose the connector socket shown in [Figure A.3, page A-2](#). (A blanking plug will be removed with the union nut. Store the union nut and blanking plug in a safe place. They will need to be reinstalled when the adapter is not in use.)
2. Wire the plug connector to an RS-485 converter cable, if it is not already attached ([Figure A.4](#)).
3. Insert the plug connector into the adapter socket.
4. Connect the converter cable to the PC or laptop.

DISCONNECTING THE COMMUNICATIONS ADAPTER

To disconnect the adapter, perform the following steps:

1. Remove the plug connector (with converter cable attached) from the socket.
2. Place the blanking plug inside the union nut (removed in step 1).
3. Screw the union nut onto the union half to cover the socket. Hand-tighten to ensure a snug connection.

Note Do not disconnect the plug connector from the RS-485 converter cable when it is not in use. For best results, store the plug connector with the converter cable.

INSTALLATION OF ADAPTER (WHEN PURCHASED SEPARATELY)



WARNING

If the communications adapter is ordered separately from the MC Synergy EXP Totalizer, the conduit openings in the enclosure will be sealed with brass or stainless steel plugs. Do not remove the plug from the enclosure to install the adapter unless the area is known to be non-hazardous.

To install a communications adapter purchased separately from an MC Synergy, perform the following steps:

1. Thread the cable of the adapter through a conduit opening in the instrument housing and screw the adapter into place.
2. Connect the adapter cable to the RS-485 port on the MC Synergy main circuit board on TB2 or TB3 (Figure A.5).
3. Connect the plug connector to an RS-485 converter cable (Figure A.4, page A-3), if applicable.

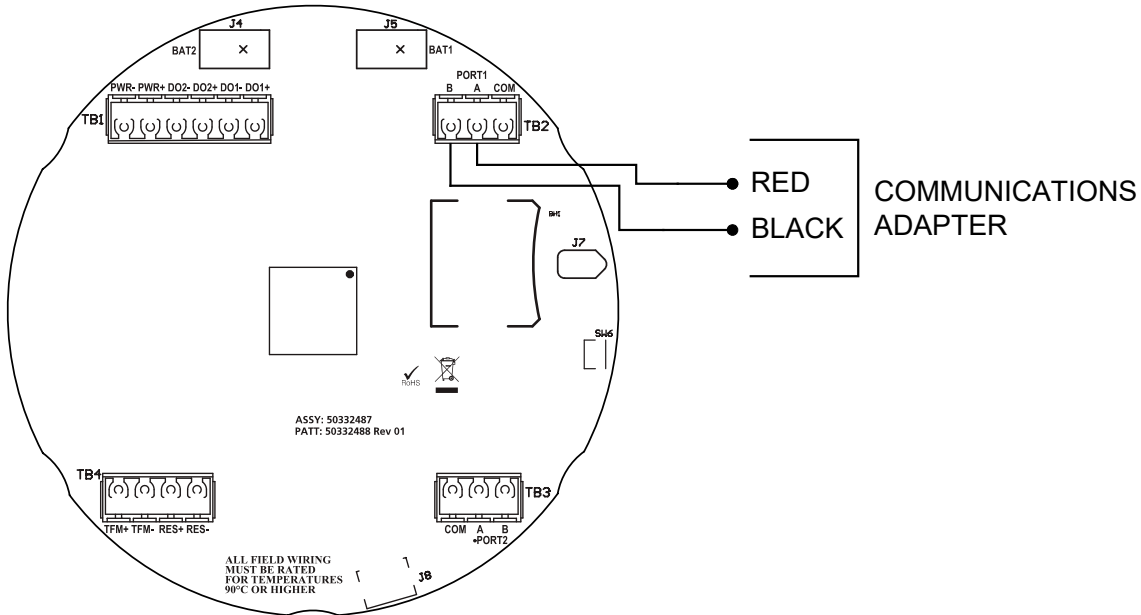

Figure A.5—Circuit board connection for communications adapter

USB COMMUNICATIONS ADAPTER

The NuFlo™ USB Adapter ([Figure A.6](#)) allows a user to connect a computer to the MC Synergy using a standard off-the-shelf USB connector cable for quick and easy downloads without opening the MC Synergy enclosure.

**CAUTION**

This adapter is CSA-approved for use in hazardous areas. It does not have ATEX/IECEX approval.

The USB adapter is comprised of a USB adapter socket, a blanking plug, and a union nut ([Figure A.7](#)). A driver required for the installation is available for download from the Sensia website.

When the USB connection is ordered with an MC Synergy, the USB adapter is pre-installed at the factory. No field wiring is required. If the USB adapter is purchased as a kit, see [Adapter Kit Installation, page A-6](#), for installation instructions.

Important Do not connect the USB adapter to a computer until a USB driver is installed. See [Using the Adapter, page A-6](#).



Figure A.6—NuFlo USB adapter



Figure A.7—NuFlo USB adapter components

USER-SUPPLIED HARDWARE

To connect the USB adapter to an MC Synergy using software, a user-supplied universal serial bus USB A/B cable is required ([Figure A.8](#)).



Figure A.8—User-supplied USB A/B cable

USING THE ADAPTER

Install the adapter as follows.

1. Download a USB driver from the Sensia website (Measurement software links).
2. Install the driver on the computer you will use to run MC Synergy software. For step-by-step installation instructions, run the executable installation file. The software will install the driver that is compatible with your computer's operating system.
3. When the software is fully installed, connect the adapter to the computer and connect to the MC Synergy (Tools/Select COM Port).



WARNING

When a hazardous area is present, ensure the union nut and blanking plug are properly fitted in the conduit opening. The explosion-proof rating applies only when the union nut and blanking plug are secured in place. When the union is broken, the device is no longer explosion-proof.



WARNING

Before disassembling the union nut and blanking plug, make sure the area is non-hazardous.

COVERING THE ADAPTER

When the USB port is not in use, nest the blanking plug inside the union nut and screw the union nut onto the adapter to cover the USB socket. Hand-tighten to ensure a snug connection.

ADAPTER KIT INSTALLATION

If the NuFlo USB adapter is purchased as a kit, connect it to the MC Synergy using the steps below.

The USB adapter is comprised of a USB adapter socket, a blanking plug, and a union nut ([Figure A.7, page A-5](#)). The blanking plug and union nut are connected to the adapter only when the USB port is not in use.

1. Remove the plug from a conduit opening in the MC Synergy enclosure.
2. Thread the cable of the adapter through the conduit opening and screw the adapter into place.
3. Connect the adapter cable to either RS-485 port on the MC Synergy main circuit board (TB2 or TB3) as shown in [Figure A.5, page A-4](#)).
4. Connect the plug connector to an RS-485 converter cable ([Figure A.9](#)), if applicable (black wire to negative terminal).

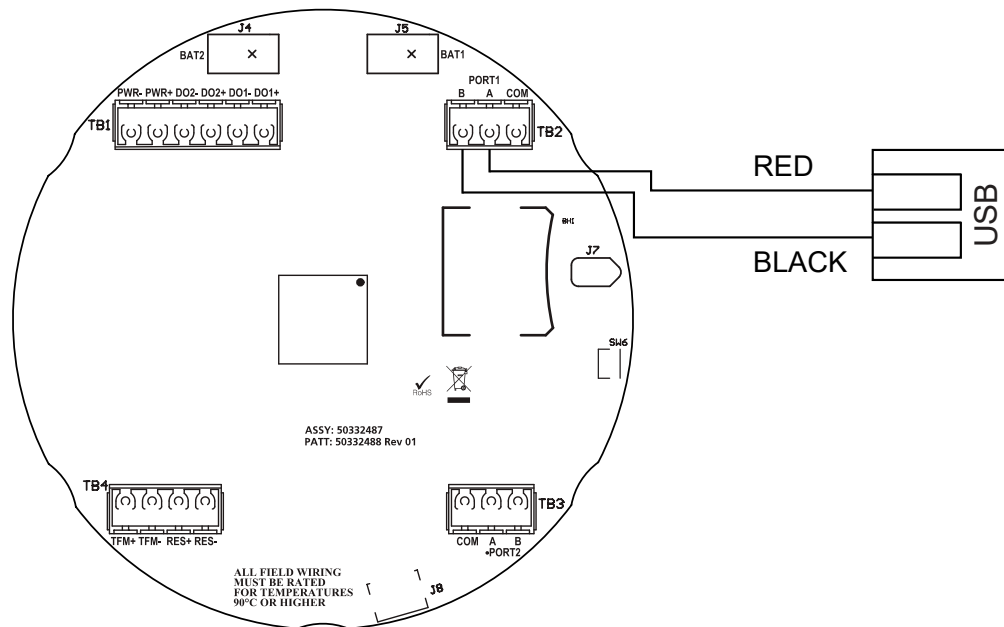

Figure A.9—Wiring of NuFlo USB adapter (required only when purchased as a kit)

If the USB port will not be used immediately, nest the blanking plug inside the union nut and screw the union nut onto the adapter to cover the USB socket. Hand-tighten to ensure a snug connection.

Important Before using the USB adapter for the first time, install a USB driver on the computer used to run MC Synergy software. For step-by-step installation instructions, run the executable installation file to install the driver that is compatible with your computer's operating system.

INSTALLING AN EXPANSION BOARD

The Analog Output/HART expansion board or the Ethernet expansion board can be installed on the MC Synergy main board using the hardware shipped with the expansion board.

- three standoffs (Part No. 77023528)
- six screws (Part No. 9A-100035734)

Important Static electricity can damage a circuit board. Handle new boards only by their edges, and use proper anti-static techniques (such as wearing anti-static wrist strap or touching metal to establish an earth ground) prior to handling a board.

To install an expansion board, perform the following steps:

1. Unscrew the cover of the enclosure counter-clockwise until it separates from the main body of the enclosure.
2. Using a small standard blade screwdriver, remove the two #4-40 × 7/8" screws located to the right and left side of the display ([Figure A.10, page A-8](#)).



Figure A.10—Removal of faceplate assembly

3. Lift the display assembly from the enclosure and place face down on a clean work surface. The main board will be fully accessible and will remain connected to the display for this procedure. For the purpose of this example, position the main board so that the battery connectors are at the top.
4. Install the three standoffs on the main board, securing each with a screw on the back side of the main board (Figure A.11).

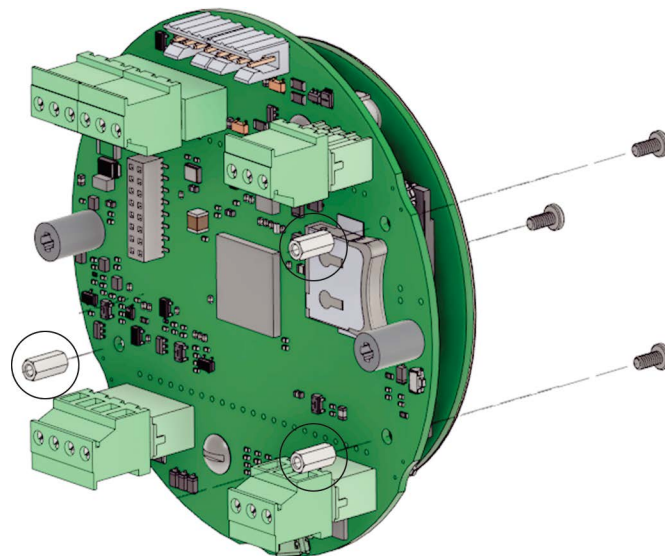

Figure A.11—Standoff installation; standoff locations are identified by three circles

5. Identify the header block on the main board (located just below TB1) that will mate with the pins on the expansion board. Orient the expansion board to visually align the pins on the back side with the main board header (Figure A.12, page A-9).

Note When installing the analog output/HART expansion board, the orientation of printed text will match the orientation of printed text on the main board. When installing the Ethernet expansion board, the TB1 power connector will be on the left edge of the board and the metallic Ethernet cable connector will be on the right edge.

- Gently place the expansion board on top of the main board, aligning three of the corner screw holes with the standoffs and apply light pressure to make the header connection.

**CAUTION**

Proceed with caution when installing an expansion board. Failure to properly align the pins with the main board header before applying pressure to the expansion board can result in bent or broken pins and irreversible damage to the expansion board.

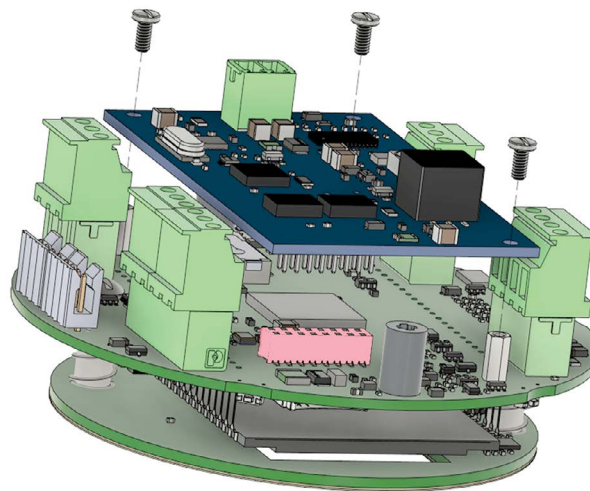

Figure A.12—Header-to-pin alignment (header color is changed for illustration purpose; the actual header is black)

- Install the three remaining screws through the corner holes of the expansion board and into the standoffs to secure the expansion board to the standoffs (Figure A.13).
- Reinstall the display assembly in the enclosure using the two screws that were removed in step 2.

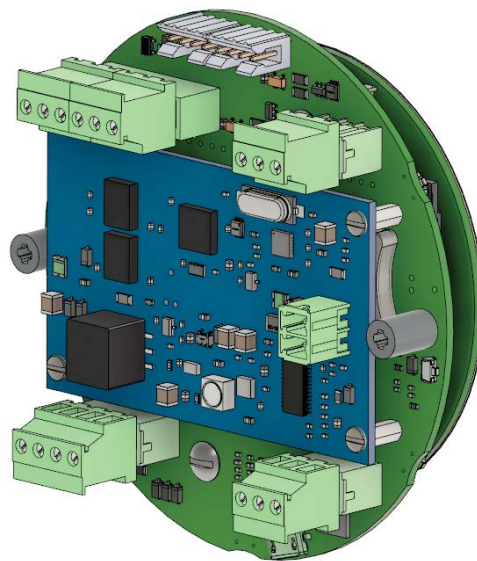

Figure A.13—Completed installation of expansion board

9. Proceed with wiring the expansion board as required:
- [Analog Output \(Expansion Board required\), page 46](#)
 - [HART Point-To-Point or Multidrop \(Expansion Board required\), page 46](#)
 - [Ethernet Communication \(Expansion Board Required\), page 48](#)

Important Connect external power to the Ethernet Expansion Board when installed. Power must be supplied to the expansion board for Ethernet to function.

10. To test expansion board connectivity following installation, tap the INC button on the keypad. If the Ethernet option board is installed, the IP address will be included in the list of scrolling parameters. If the analog output option board is installed, loop voltage will be displayed.

Appendix B—Lithium Battery Information

LITHIUM BATTERY DISPOSAL

Once a lithium battery is removed from a device and/or is destined for disposal, it is classified as solid waste under EPA guidelines. Depleted lithium batteries are also considered to be hazardous waste because they meet the definition of Reactivity, as per 40 CFR 261.23(a)(2), (3) and (5). This document describes how the lithium reacts violently with water, forms potentially explosive mixtures with water, and when exposed to certain pH conditions, generates toxic cyanide or sulfide gases.

Federal law requires that depleted lithium batteries be sent to a fully permitted Treatment, Storage and Disposal Facility (TSDF) or to a permitted recycling/reclamation facility.

Important Do not ship lithium batteries to Sensia. Sensia facilities are not permitted recycling/ reclamation facilities.



CAUTION

Profiling and waste characterization procedures must be followed prior to shipping a lithium battery to a disposal site. It is the shipper's responsibility to comply with all applicable federal transportation regulations (see below).

TRANSPORTATION INFORMATION



WARNING

The MC Synergy EXP Totalizer may contain lithium batteries. The internal component (thionyl chloride) is hazardous under the criteria of the Federal OSHA Hazard Communication Standard 29 CFR 1920.1200. Before shipping a lithium battery or equipment containing a lithium battery, verify that the packaging and labeling conforms with the latest version of all applicable regulations.

The transport of the lithium batteries is regulated by the United Nations, "Model Regulations on Transport of Dangerous Goods," (special provisions 188, 230, and 310), latest revision.

Within the US the lithium batteries and cells are subject to shipping requirements under Part 49 of the Code of Federal Regulations (49 CFR, Parts 171, 172, 173, and 175) of the US Hazardous Materials Regulations (HMR), latest revision.

Shipping of lithium batteries in aircraft is regulated by the International Civil Aviation Organization (ICAO) and the International Air Transport Association (IATA) requirements in Special Provisions A45, A88 and A99, latest revision.

Shipping of lithium batteries on sea is regulated the International Maritime Dangerous Goods (IMDG) requirements in special provisions 188, 230 and 310, latest revision.

Shipping of lithium batteries on road and rail is regulated by requirements in special provisions 188, 230 and 310, latest revision.

CUSTOMER SUPPORT

For technical support involving lithium batteries, contact Sensia at <https://www.sensiaglobal.com/Technical-Support> or call 1-866-773-6742.

Page intentionally left blank

Appendix C—Modbus Protocol

INTRODUCTION

The communications protocol for the MC Synergy is in accordance with Modicon, Inc. RTU Mode Modbus as described in Modicon Modbus Protocol Reference Guide, PI-MBUS-300 Rev. J, June 1996. All registers are implemented as 4X or holding registers. Reading of registers is implemented via function code 03H (Read Holding Registers) or function code 04H (Read Input Registers). Writing to registers is implemented via function code 10H (Preset Multiple Registers).

The instrument provides Enron Modbus compliant downloads for interval, daily and event records. For details on Enron Modbus, refer to Specifications and Requirements for an Electronic Flow Measurement Remote Terminal Unit for Enron Corp., Dec. 5, 1994.

When the Ethernet option board is installed, the MC Synergy also supports Modbus TCP and Modbus Over TCP protocols.

SUPPORTED COMMANDS

The Modbus functions supported by the MC Synergy are as follows:

Function Code (Hex)	Description
03	Read Holding Registers
04	Read Input Registers
05	Preset Boolean (for Enron event record acknowledgement)
10	Preset Multiple Registers

For the read holding and preset multiple registers, the instrument supports the full 250 bytes of data in a message. This corresponds to 125 registers in 16-bit holding register size and 62 registers in 32-bit holding register size.

DATA TYPES

Various data types are implemented in the MC Synergy. The following table lists the formats and the numbers of bytes and registers associated with each type.

Data Type	Byte Count
Floating Point (FLOAT)	4
Integer (INT16)	2
Long Int (INT32)	4
Packed ASCII (String[2])	2

The Floating Point (FLOAT) type follows the IEEE-754 format and consists of 32 bits contained in either two registers in 16-bit maps or one register in a 32-bit map. It is utilized for parameters and values that are not integers. For example, Instantaneous Flow Rate is a parameter that is a floating-point data type. It can be interpreted by reading two registers, starting with register 17013.

The standard word ordering for multiple register data types, such as floating-point numbers or long integers, is for the most significant word to appear first in the message. The standard byte order is high bytes appear first in the message.

The Packed ASCII (String[2]) type contains two bytes that are two unsigned characters. Generally, multiple Packed ASCII types are arranged consecutively for implementing strings. For example, the device's well name is a string of 10 unsigned characters that is implemented as 5 Packed ASCII registers. Here is an example of a well name that contains the string, "Test Well 413."

Register	Hexadecimal #	ASCII Characters
210	54 65	Te
211	73 74	st
212	20 57	<SPACE>W
213	65 6C	eI
214	6C 20	I<SPACE>
215	34 31	41
216	33 FF	3<UNUSED>

Unused characters at the end of each string will report 0xFF hexadecimal.

REGISTERS

Each register has an access type: read-only or read-write, as described below.

Access Type	Description
Read Only (RO)	Register can only be read.
Read/Write (R/W)	Register can be read and written.

The registers are grouped into Modbus map blocks based on function. Please see the register sections provided in the following Modbus map.

Note All registers cited in this document refer to the address of the register that appears in the actual Modbus message. For example, register 17001 has an address of 0x4268 Hexadecimal in the message.

Note Two sets of 16-bit holding registers are provided (starting at 17001 and 8000). The "8000" set should be used with master devices that require the holding registers to be in the range of 40000 to 49999.

MODBUS MAP

REGISTER TABLE VERSION 7

Register Sections	Starting Address	Register Size
Event Access	32	16-Bit
Control Registers	70	16-Bit
Informer Units	135	16-Bit
User Configuration 1	200	16-Bit
User Configuration 2	300	16-Bit
Turbine Meter Strings	400	16-Bit
User Configuration 3	500	16-Bit
Informer Total	548	16-Bit
Main Board Information	600	16-Bit
Expansion Board Information	650	16-Bit
Record Access	700	16-Bit
System Configuration	1000	16-Bit
Ports Configuration	1100	16-Bit
Real Time	1200	16-Bit
Input Configuration	2000	16-Bit
Turbine Meter Info	2100	16-Bit
Turbine Input Configuration	2200	16-Bit
Turbine Meter Calibration	2300	16-Bit
Output Configuration	4000	16-Bit
Digital Output Configuration	4100	16-Bit
Alarm Configuration	4200	16-Bit
Archive Configuration	4300	16-Bit
Network Settings	4900	16-Bit
Holding Registers - Enron 32-bit	7000	32-Bit
Holding Registers Ext - Enron 32-bit	7200	32-Bit
Holding Registers	8000	16-Bit
Holding Registers Ext	8200	16-Bit
Holding Registers - System Alarms	8400	16-Bit
Holding Registers - Turbine Alarms	8500	16-Bit
Holding Registers - User Alarms	8600	16-Bit
Holding Registers - Serial Status	8800	16-Bit
Holding Registers - Network Status	8900	16-Bit
Holding Registers - MC-III	17001	16-Bit

Event Access		Register Size: 16-Bit	
Register (Decimal)	Register (Hex)	Description	Data Type
32	0020	Event Log	INT16

Control Registers		Register Size: 16-Bit	
Register (Decimal)	Register (Hex)	Description	Data Type
70	0046	Control Register 1	INT16
71	0047	Control Register 2	INT16
72	0048	Control Register 3	INT16
73	0049	Control Register 4	INT16
74	004A	Control Register 5	INT16
75	004B	Command Response	INT16

Informer Units		Register Size: 16-Bit	
Register (Decimal)	Register (Hex)	Description	Data Type
135	0087	Volume Units	INT16

User Configuration 1		Register Size: 16-Bit	
Register (Decimal)	Register (Hex)	Description	Data Type
200	00C8	Data 01 - Company Name (20 char)	String[2]
201	00C9	Data 02	String[2]
202	00CA	Data 03	String[2]
203	00CB	Data 04	String[2]
204	00CC	Data 05	String[2]
205	00CD	Data 06	String[2]
206	00CE	Data 07	String[2]
207	00CF	Data 08	String[2]
208	00D0	Data 09	String[2]
209	00D1	Data 10	String[2]
210	00D2	Data 11 - Site/Well Name (20 char)	String[2]
211	00D3	Data 12	String[2]
212	00D4	Data 13	String[2]
213	00D5	Data 14	String[2]
214	00D6	Data 15	String[2]
215	00D7	Data 16	String[2]
216	00D8	Data 17	String[2]
217	00D9	Data 18	String[2]
218	00DA	Data 19	String[2]
219	00DB	Data 20	String[2]

User Configuration 1		Register Size: 16-Bit	
Register (Decimal)	Register (Hex)	Description	Data Type
220	00DC	Data 21 - Location Name (20 char)	String[2]
221	00DD	Data 22	String[2]
222	00DE	Data 23	String[2]
223	00DF	Data 24	String[2]
224	00E0	Data 25	String[2]
225	00E1	Data 26	String[2]
226	00E2	Data 27	String[2]
227	00E3	Data 28	String[2]
228	00E4	Data 29	String[2]
229	00E5	Data 30	String[2]
230	00E6	Data 31	String[2]
231	00E7	Data 32	String[2]

User Configuration 2		Register Size: 16-Bit	
Register (Decimal)	Register (Hex)	Description	Data Type
300	012C	Data 01 - Field/Lease Name (20 char)	String[2]
301	012D	Data 02	String[2]
302	012E	Data 03	String[2]
303	012F	Data 04	String[2]
304	0130	Data 05	String[2]
305	0131	Data 06	String[2]
306	0132	Data 07	String[2]
307	0133	Data 08	String[2]
308	0134	Data 09	String[2]
309	0135	Data 10	String[2]
310	0136	Data 11 - Device/Meter Name (10 char)	String[2]
311	0137	Data 12	String[2]
312	0138	Data 13	String[2]
313	0139	Data 14	String[2]
314	013A	Data 15	String[2]
315	013B	Data 16 - Legal Description (34 char)	String[2]
316	013C	Data 17	String[2]
317	013D	Data 18	String[2]
318	013E	Data 19	String[2]
319	013F	Data 20	String[2]
320	0140	Data 21	String[2]
321	0141	Data 22	String[2]
322	0142	Data 23	String[2]

User Configuration 2		Register Size: 16-Bit	
Register (Decimal)	Register (Hex)	Description	Data Type
323	0143	Data 24	String[2]
324	0144	Data 25	String[2]
325	0145	Data 26	String[2]
326	0146	Data 27	String[2]
327	0147	Data 28	String[2]
328	0148	Data 29	String[2]
329	0149	Data 30	String[2]
330	014A	Data 31	String[2]
331	014B	Data 32	String[2]

Turbine Meter Strings		Register Size: 16-Bit	
Register (Decimal)	Register (Hex)	Description	Data Type
400	0190	Meter Part No (20 char)	String[2]
401	0191	Meter Part No 02	String[2]
402	0192	Meter Part No 03	String[2]
403	0193	Meter Part No 04	String[2]
404	0194	Meter Part No 05	String[2]
405	0195	Meter Part No 06	String[2]
406	0196	Meter Part No 07	String[2]
407	0197	Meter Part No 08	String[2]
408	0198	Meter Part No 09	String[2]
409	0199	Meter Part No 10	String[2]
410	019A	Meter Serial No (20 char)	String[2]
411	019B	Meter Serial No 02	String[2]
412	019C	Meter Serial No 03	String[2]
413	019D	Meter Serial No 04	String[2]
414	019E	Meter Serial No 05	String[2]
415	019F	Meter Serial No 06	String[2]
416	01A0	Meter Serial No 07	String[2]
417	01A1	Meter Serial No 08	String[2]
418	01A2	Meter Serial No 09	String[2]
419	01A3	Meter Serial No 10	String[2]
420	01A4	Measurement Type (20 char)	String[2]
421	01A5	Measurement Type 02	String[2]
422	01A6	Measurement Type 03	String[2]
423	01A7	Measurement Type 04	String[2]
424	01A8	Measurement Type 05	String[2]
425	01A9	Measurement Type 06	String[2]

Turbine Meter Strings		Register Size: 16-Bit	
Register (Decimal)	Register (Hex)	Description	Data Type
426	01AA	Measurement Type 07	String[2]
427	01AB	Measurement Type 08	String[2]
428	01AC	Measurement Type 09	String[2]
429	01AD	Measurement Type 10	String[2]
430	01AE	Measurement Type 11	String[2]
431	01AF	Measurement Type 12	String[2]
432	01B0	Meter Model (20 char)	String[2]
433	01B1	Meter Model 02	String[2]
434	01B2	Meter Model 03	String[2]
435	01B3	Meter Model 04	String[2]
436	01B4	Meter Model 05	String[2]
437	01B5	Meter Model 06	String[2]
438	01B6	Meter Model 07	String[2]
439	01B7	Meter Model 08	String[2]
440	01B8	Meter Model 09	String[2]
441	01B9	Meter Model 10	String[2]

User Configuration 3		Register Size: 16-Bit	
Register (Decimal)	Register (Hex)	Description	Data Type
500	01F4	Data 01 - User Note (64 char)	String[2]
501	01F5	Data 02	String[2]
502	01F6	Data 03	String[2]
503	01F7	Data 04	String[2]
504	01F8	Data 05	String[2]
505	01F9	Data 06	String[2]
506	01FA	Data 07	String[2]
507	01FB	Data 08	String[2]
508	01FC	Data 09	String[2]
509	01FD	Data 10	String[2]
510	01FE	Data 11	String[2]
511	01FF	Data 12	String[2]
512	0200	Data 13	String[2]
513	0201	Data 14	String[2]
514	0202	Data 15	String[2]
515	0203	Data 16	String[2]
516	0204	Data 17	String[2]
517	0205	Data 18	String[2]
518	0206	Data 19	String[2]

User Configuration 3		Register Size: 16-Bit	
Register (Decimal)	Register (Hex)	Description	Data Type
519	0207	Data 20	String[2]
520	0208	Data 21	String[2]
521	0209	Data 22	String[2]
522	020A	Data 23	String[2]
523	020B	Data 24	String[2]
524	020C	Data 25	String[2]
525	020D	Data 26	String[2]
526	020E	Data 27	String[2]
527	020F	Data 28	String[2]
528	0210	Data 29	String[2]
529	0211	Data 30	String[2]
530	0212	Data 31	String[2]
531	0213	Data 32	String[2]

Informer Total		Register Size: 16-Bit	
Register (Decimal)	Register (Hex)	Description	Data Type
548	0224	Total Volume	FLOAT

Main Board Information		Register Size: 16-Bit	
Register (Decimal)	Register (Hex)	Description	Data Type
600	0258	Product Code	INT16
601	0259	Register Table Version	INT16
602	025A	XML Hash Code	INT32
604	025C	Firmware Version	INT16
605	025D	Manufacture Date	INT32
607	025F	Sales Date	INT32
609	0261	Serial Number High	INT32
611	0263	Serial Number Low	INT32
613	0265	Product Revision	INT32
615	0267	Hardware Hash Code	INT32
617	0269	Software Hash Code	INT32
619	026B	Active ROM Bank	INT16

Expansion Board Information		Register Size: 16-Bit	
Register (Decimal)	Register (Hex)	Description	Data Type
650	028A	Board Type	INT16
651	028B	Firmware Version	FLOAT

Expansion Board Information		Register Size: 16-Bit	
Register (Decimal)	Register (Hex)	Description	Data Type
653	028D	Firmware Hash	INT32
655	028F	Serial Number	INT32
657	0291	Manufacture Date	INT32
659	0293	Sales Date	INT32
661	0295	Mode	INT16
662	0296	Config Counter	INT16

Record Access		Register Size: 16-Bit	
Register (Decimal)	Register (Hex)	Description	Data Type
700	02BC	Interval Log	INT16
701	02BD	Daily Log	INT16

SYSTEM CONFIGURATION

The System Configuration Map beginning at register 1000 is provided for NUFLO MC-III compatibility. For new projects, the following maps provide additional functionality:

- Main Board Information - 600
- Expansion Board Information - 650
- Ports Configuration - 1100
- Archive Configuration - 4300

System Configuration		Register Size: 16-Bit	
Register (Decimal)	Register (Hex)	Description	Data Type
1000	03E8	Product Code	INT16
1001	03E9	Register Table Version	INT16
1002	03EA	Firmware Version	INT16
1003	03EB	Manufacture Date	INT16
1004	03EC	Sales Date	INT16
1005	03ED	Serial Number High	INT16
1006	03EE	Serial Number Low	INT16
1007	03EF	Power Mode	INT16
1008	03F0	Internal System Sample Period	INT16
1009	03F1	Port0 - Slave Address	INT16
1010	03F2	Port0 - Baud Rate	INT16
1011	03F3	Port0 - Bus Delay	INT16
1012	03F4	Port0 - Bus Timeout	INT16
1013	03F5	Contract Hour	INT16
1014	03F6	Keypad Lock Code	INT16

System Configuration		Register Size: 16-Bit	
Register (Decimal)	Register (Hex)	Description	Data Type
1015	03F7	Keypad Lock Enable	INT16
1016	03F8	LCD Contrast Setting	INT16

PRODUCT CODE (REGISTER 1000)

The Product Code is a read-only parameter used for identification. This parameter is set at the factory and it will always read 0x40 hexadecimal (64 decimal).

FIRMWARE/REGISTER TABLE VERSION NUMBERS (REGISTERS 1001, 1002)

The Firmware Version and Register Table Version numbers are unsigned 16-bit integers. These parameters are set at the factory and are read-only. To determine the firmware version number, read the appropriate register and divide the value read by 100. The general format for firmware version numbers is A.BC. For example, the firmware register number is read as 0xA7 hexadecimal. This represents 167 and a firmware version of 1.67.

MANUFACTURE DATE/SALES DATE (REGISTERS 1003, 1004)

These parameters are set at the factory and are read-only. These registers are formatted as MMY. For example, a value of 0923 represents September 2023.

SLAVE ADDRESS (REGISTER 1009)

The Modbus slave address is a signed integer (INT16) data type that has a range of values from 1 to 65535. The slave address is configured from a laptop or via the keypad and is stored in nonvolatile memory.

When the slave address is written, the response message will be at the current address. After the response message is transmitted, the MC Synergy will change to the new slave address.

BAUD RATE (REGISTER 1010, 1102, 1109)

The baud rate is an unsigned integer (INT16) data type that sets the data rate on the serial port. When the baud rate is written, the response message will be at the current baud rate. After the response message is transmitted, the MC Synergy will change to the new baud rate. Register 1010 is provided for NUFLO MC-III compatibility and is used for Port 1 on the MC Synergy. For all other MC Synergy communications, use baud rate registers 1102 and 1109.

Baud	Baud Rate Configuration Register Enumeration
300	0
600	Not Supported
1200	1
2400	2
4800	3
9600	4 or 5
19200	6
38400	7

Baud	Baud Rate Configuration Register Enumeration
57600	8

Units	Units x 1000 ¹
0 = No Units	16 = No Units
1 = Gallons	17 = Gallons
2 = Barrels	18 = Barrels
3 = Cubic Meters	19 = Cubic Meters
4 = Cubic Feet	20 = Cubic Feet
5 = Liters	21 = Liters

1. The x1000 unit configuration does not apply to Meter Range or K-Factor units.

Rate Time Base	
0	Second
1	Minute
2	Hour
3	Day

Ports Configuration		Register Size: 16-Bit	
Register (Decimal)	Register (Hex)	Description	Data Type
1100	044C	Port0 - Mode	INT16
1101	044D	Port0 - Slave Address	INT16
1102	044E	Port0 - Baud Rate	INT16
1103	044F	Port0 - Bus Delay	INT16
1104	0450	Port0 - Bus Timeout	INT16
1105	0451	Port0 - Register Range High	INT16
1106	0452	Port0 - Register Range Low	INT16
1107	0453	Port1 - Mode	INT16
1108	0454	Port1 - Slave Address	INT16
1109	0455	Port1 - Baud Rate	INT16
1110	0456	Port1 - Bus Delay	INT16
1111	0457	Port1 - Bus Timeout	INT16
1112	0458	Port1 - Register Range High	INT16
1113	0459	Port1 - Register Range Low	INT16
1114	045A	TCPPort1 - Mode	INT16
1115	045B	TCPPort1 - Unit ID	INT16
1116	045C	TCPPort1 - Register Range High	INT16
1117	045D	TCPPort1 - Register Range Low	INT16
1118	045E	TCPPort2 - Mode	INT16

Ports Configuration		Register Size: 16-Bit	
Register (Decimal)	Register (Hex)	Description	Data Type
1119	045F	TCPPort2 - Slave Address	INT16
1120	0460	TCPPort2 - Register Range High	INT16
1121	0461	TCPPort2 - Register Range Low	INT16

Real Time		Register Size: 16-Bit	
Register (Decimal)	Register (Hex)	Description	Data Type
1200	04B0	Real Year	INT16
1201	04B1	Real Month	INT16
1202	04B2	Real Day	INT16
1203	04B3	Real Hour	INT16
1204	04B4	Real Minute	INT16
1205	04B5	Real Second	INT16
1206	04B6	Keypad	INT16
1207	04B7	Real Date	INT32
1209	04B9	Real Time	INT32
1211	04BB	Day Of Week	INT32
1213	04BD	Seconds Elapsed In Day	INT32
1215	04BF	BLE Session Time	INT16
1216	04C0	BLE Advertise Time	INT16
1217	04C1	Config Save Pending	INT16
1218	04C2	Current Sleep Level Minimum	INT16
1219	04C3	Current Sleep Level Maximum	INT16
1220	04C4	CPU Percentage	FLOAT

INPUT CONFIGURATION

The Input Configuration Map beginning at register 2000 is provided for NUFLO MC-III compatibility. For new projects, the following maps provide additional functionality:

- Turbine Input Configuration - 2200
- Turbine Meter Calibration - 2300

Input Configuration		Register Size: 16-Bit	
Register (Decimal)	Register (Hex)	Description	Data Type
2000	07D0	T1 - Volume Units	INT16
2001	07D1	T1 - Volume Decimal	INT16
2002	07D2	T1 - Rate Volume Units	INT16
2003	07D3	T1 - Rate Time Base	INT16
2004	07D4	T1 - Rate Decimal	INT16

Input Configuration		Register Size: 16-Bit	
Register (Decimal)	Register (Hex)	Description	Data Type
2005	07D5	T1 - Sample Period	INT16
2006	07D6	T1 - Amplifier Setting	INT16
2007	07D7	T1 - Low Freq. Cutoff	INT16
2008	07D8	T1 - Factor Type	INT16
2009	07D9	T1 - Factor Units	INT16
2010	07DA	T1 - Factor Decimal	INT16
2011	07DB	T1 - Frequency 1	FLOAT
2013	07DD	T1 - Frequency 2	FLOAT
2015	07DF	T1 - Frequency 3	FLOAT
2017	07E1	T1 - Frequency 4	FLOAT
2019	07E3	T1 - Frequency 5	FLOAT
2021	07E5	T1 - Frequency 6	FLOAT
2023	07E7	T1 - Frequency 7	FLOAT
2025	07E9	T1 - Frequency 8	FLOAT
2027	07EB	T1 - Frequency 9	FLOAT
2029	07ED	T1 - Frequency 10	FLOAT
2031	07EF	T1 - Frequency 11	FLOAT
2033	07F1	T1 - Frequency 12	FLOAT
2035	07F3	T1 - Factor 1	FLOAT
2037	07F5	T1 - Factor 2	FLOAT
2039	07F7	T1 - Factor 3	FLOAT
2041	07F9	T1 - Factor 4	FLOAT
2043	07FB	T1 - Factor 5	FLOAT
2045	07FD	T1 - Factor 6	FLOAT
2047	07FF	T1 - Factor 7	FLOAT
2049	0801	T1 - Factor 8	FLOAT
2051	0803	T1 - Factor 9	FLOAT
2053	0805	T1 - Factor 10	FLOAT
2055	0807	T1 - Factor 11	FLOAT
2057	0809	T1 - Factor 12	FLOAT
2059	080B	T1 - Correction Factor	FLOAT
2061	080D	T1 - Low Flow Cutoff	FLOAT

Turbine Meter Info		Register Size: 16-Bit	
Register (Decimal)	Register (Hex)	Description	Data Type
2100	0834	T1 - Meter Range Units	INT16
2101	0835	T1 - Meter Range Time Base	INT16
2102	0836	T1 - Meter Range Low	FLOAT

Turbine Meter Info		Register Size: 16-Bit	
Register (Decimal)	Register (Hex)	Description	Data Type
2104	0838	T1 - Meter Range High	FLOAT
2106	083A	T1 - Number Of Blades	INT16
2107	083B	T1 - Meter Body Diameter	FLOAT
2109	083D	T1 - Meter Kit Life	INT16

TURBINE METER INPUT CONFIGURATION

The Turbine meter input configuration is defined by the following table. The Pulse Input Type and the Input Threshold registers are used to set the input mode. The Input Configuration Register (2006) is shown for compatibility.

	MC Synergy		MC-III Compatibility
	Pulse Input Type (Register 2201)	Pulse Input Threshold (Register 2202)	Input Configuration (Register 2006)
Digital Pulse Input	0	3	0
Turbine Input (Low)	1	0	1
Turbine Input (Med)	1	1	2
Turbine Input (High)	1	2	3
Contact Closure	2	3	N/A

Turbine Input Configuration		Register Size: 16-Bit	
Register (Decimal)	Register (Hex)	Description	Data Type
2200	0898	T1 - Sample Period	INT16
2201	0899	T1 - Pulse Input Type	INT16
2202	089A	T1 - Input Threshold	INT16
2203	089B	T1 - Low Freq. Cutoff	INT16
2204	089C	T1 - Low Flow Cutoff	FLOAT
2206	089E	T1 - Rate Damping Factor	INT16
2207	089F	T1 - Volume Units	INT16
2208	08A0	T1 - Volume Decimal	INT16
2209	08A1	T1 - Rate Volume Units	INT16
2210	08A2	T1 - Rate Time Base	INT16
2211	08A3	T1 - Rate Decimal	INT16
2212	08A4	T1 - Health Test Period	INT16
2213	08A5	T1 - Bent Blade Event Count	INT16
2214	08A6	T1 - Bent Blade Event Time	INT16
2215	08A7	T1 - Missing Blade Event Count	INT16
2216	08A8	T1 - Missing Blade Event Time	INT16
2217	08A9	T1 - Erratic Signal Event Count	INT16
2218	08AA	T1 - Erratic Signal Event Time	INT16

Turbine Meter Calibration		Register Size: 16-Bit	
Register (Decimal)	Register (Hex)	Description	Data Type
2300	08FC	T1 - K Factor Type	INT16
2301	08FD	T1 - K Factor Units	INT16
2302	08FE	T1 - K Factor Decimal	INT16
2303	08FF	T1 - Number of K Factor Points	INT16
2304	0900	T1 - Linear K Factor	FLOAT
2306	0902	T1 - K Factor Frequency 1	FLOAT
2308	0904	T1 - K Factor Frequency 2	FLOAT
2310	0906	T1 - K Factor Frequency 3	FLOAT
2312	0908	T1 - K Factor Frequency 4	FLOAT
2314	090A	T1 - K Factor Frequency 5	FLOAT
2316	090C	T1 - K Factor Frequency 6	FLOAT
2318	090E	T1 - K Factor Frequency 7	FLOAT
2320	0910	T1 - K Factor Frequency 8	FLOAT
2322	0912	T1 - K Factor Frequency 9	FLOAT
2324	0914	T1 - K Factor Frequency 10	FLOAT
2326	0916	T1 - K Factor Frequency 11	FLOAT
2328	0918	T1 - K Factor Frequency 12	FLOAT
2330	091A	T1 - K Factor 1	FLOAT
2332	091C	T1 - K Factor 2	FLOAT
2334	091E	T1 - K Factor 3	FLOAT
2336	0920	T1 - K Factor 4	FLOAT
2338	0922	T1 - K Factor 5	FLOAT
2340	0924	T1 - K Factor 6	FLOAT
2342	0926	T1 - K Factor 7	FLOAT
2344	0928	T1 - K Factor 8	FLOAT
2346	092A	T1 - K Factor 9	FLOAT
2348	092C	T1 - K Factor 10	FLOAT
2350	092E	T1 - K Factor 11	FLOAT
2352	0930	T1 - K Factor 12	FLOAT
2354	0932	T1 - Meter Factor Type	INT16
2355	0933	T1 - Meter Factor Units	INT16
2356	0934	T1 - Meter Factor Decimal	INT16
2357	0935	T1 - Number of Meter Factor Points	INT16
2358	0936	T1 - Linear Meter Factor	FLOAT
2360	0938	T1 - Meter Factor Frequency 1	FLOAT
2362	093A	T1 - Meter Factor Frequency 2	FLOAT
2364	093C	T1 - Meter Factor Frequency 3	FLOAT
2366	093E	T1 - Meter Factor Frequency 4	FLOAT

Turbine Meter Calibration		Register Size: 16-Bit	
Register (Decimal)	Register (Hex)	Description	Data Type
2368	0940	T1 - Meter Factor Frequency 5	FLOAT
2370	0942	T1 - Meter Factor Frequency 6	FLOAT
2372	0944	T1 - Meter Factor Frequency 7	FLOAT
2374	0946	T1 - Meter Factor Frequency 8	FLOAT
2376	0948	T1 - Meter Factor Frequency 9	FLOAT
2378	094A	T1 - Meter Factor Frequency 10	FLOAT
2380	094C	T1 - Meter Factor Frequency 11	FLOAT
2382	094E	T1 - Meter Factor Frequency 12	FLOAT
2384	0950	T1 - Meter Factor 1	FLOAT
2386	0952	T1 - Meter Factor 2	FLOAT
2388	0954	T1 - Meter Factor 3	FLOAT
2390	0956	T1 - Meter Factor 4	FLOAT
2392	0958	T1 - Meter Factor 5	FLOAT
2394	095A	T1 - Meter Factor 6	FLOAT
2396	095C	T1 - Meter Factor 7	FLOAT
2398	095E	T1 - Meter Factor 8	FLOAT
2400	0960	T1 - Meter Factor 9	FLOAT
2402	0962	T1 - Meter Factor 10	FLOAT
2404	0964	T1 - Meter Factor 11	FLOAT
2406	0966	T1 - Meter Factor 12	FLOAT

OUTPUT CONFIGURATION

The Output Configuration Map beginning at register 4000 is provided for NUFLO MC-III compatibility. For new projects, see Digital Output Configuration beginning at register 4100 for additional functionality.

Output Configuration		Register Size: 16-Bit	
Register (Decimal)	Register (Hex)	Description	Data Type
4000	0FA0	Pulse Out 1 - Register	INT16
4001	0FA1	Pulse Out 1 - Duration	INT16
4002	0FA2	Pulse Out 1 - Decimal Location	INT16
4003	0FA3	Pulse Out 1 - Scale Factor	FLOAT
4005	0FA5	Analog Out 1 - Register	INT16
4006	0FA6	Analog Out 1 - Decimal Location	INT16
4007	0FA7	Analog Out 1 - Low Value	FLOAT
4009	0FA9	Analog Out 1 - High Value	FLOAT

Digital Output Configuration		Register Size: 16-Bit	
Register (Decimal)	Register (Hex)	Description	Data Type
4100	1004	Digital Out 1 - Mode	INT16
4101	1005	Digital Out 1 - Register	INT16
4102	1006	Digital Out 1 - Units	INT16
4103	1007	Digital Out 1 - Duration	INT16
4104	1008	Digital Out 1 - Decimal Location	INT16
4105	1009	Digital Out 1 - Scale Factor	FLOAT
4107	100B	Digital Out 1 - Scale Factor Units	INT16
4108	100C	Digital Out 1 - Output State	INT16
4109	100D	Digital Out 1 - Output Latching	INT16
4110	100E	Digital Out 1 - Alarm Mode	INT16
4111	100F	Digital Out 1 - System Alarm Select	INT16
4112	1010	Digital Out 1 - PulseIn Alarm Select	INT16
4113	1011	Digital Out 2 - Mode	INT16
4114	1012	Digital Out 2 - Register	INT16
4115	1013	Digital Out 2 - Units	INT16
4116	1014	Digital Out 2 - Duration	INT16
4117	1015	Digital Out 2 - Decimal Location	INT16
4118	1016	Digital Out 2 - Scale Factor	FLOAT
4120	1018	Digital Out 2 - Scale Factor Units	INT16
4121	1019	Digital Out 2 - Output State	INT16
4122	101A	Digital Out 2 - Output Latching	INT16
4123	101B	Digital Out 2 - Alarm Mode	INT16
4124	101C	Digital Out 2 - System Alarm Select	INT16
4125	101D	Digital Out 2 - PulseIn Alarm Select	INT16

Alarm Configuration		Register Size: 16-Bit	
Register (Decimal)	Register (Hex)	Description	Data Type
4200	1068	Alarms Enabled	INT16
4201	1069	Alarm 1 - Register	INT16
4202	106A	Alarm 1 - Threshold Type	INT16
4203	106B	Alarm 1 - Units Selection	INT16
4204	106C	Alarm 1 - High Threshold	FLOAT
4206	106E	Alarm 1 - Low Threshold	FLOAT
4208	1070	Alarm 1 - Dead Band	FLOAT
4210	1072	Alarm 1 - Hold-Off Period	INT16
4211	1073	Alarm 2 - Register	INT16
4212	1074	Alarm 2 - Threshold Type	INT16
4213	1075	Alarm 2 - Units Selection	INT16

Alarm Configuration		Register Size: 16-Bit	
Register (Decimal)	Register (Hex)	Description	Data Type
4214	1076	Alarm 2 - High Threshold	FLOAT
4216	1078	Alarm 2 - Low Threshold	FLOAT
4218	107A	Alarm 2 - Dead Band	FLOAT
4220	107C	Alarm 2 - Hold-Off Period	INT16
4221	107D	Alarm 3 - Register	INT16
4222	107E	Alarm 3 - Threshold Type	INT16
4223	107F	Alarm 3 - Units Selection	INT16
4224	1080	Alarm 3 - High Threshold	FLOAT
4226	1082	Alarm 3 - Low Threshold	FLOAT
4228	1084	Alarm 3 - Dead Band	FLOAT
4230	1086	Alarm 3 - Hold-Off Period	INT16
4231	1087	Alarm 4 - Register	INT16
4232	1088	Alarm 4 - Threshold Type	INT16
4233	1089	Alarm 4 - Units Selection	INT16
4234	108A	Alarm 4 - High Threshold	FLOAT
4236	108C	Alarm 4 - Low Threshold	FLOAT
4238	108E	Alarm 4 - Dead Band	FLOAT
4240	1090	Alarm 4 - Hold-Off Period	INT16
4241	1091	Alarm 5 - Register	INT16
4242	1092	Alarm 5 - Threshold Type	INT16
4243	1093	Alarm 5 - Units Selection	INT16
4244	1094	Alarm 5 - High Threshold	FLOAT
4246	1096	Alarm 5 - Low Threshold	FLOAT
4248	1098	Alarm 5 - Dead Band	FLOAT
4250	109A	Alarm 5 - Hold-Off Period	INT16
4251	109B	Alarm 6 - Register	INT16
4252	109C	Alarm 6 - Threshold Type	INT16
4253	109D	Alarm 6 - Units Selection	INT16
4254	109E	Alarm 6 - High Threshold	FLOAT
4256	10A0	Alarm 6 - Low Threshold	FLOAT
4258	10A2	Alarm 6 - Dead Band	FLOAT
4260	10A4	Alarm 6 - Hold-Off Period	INT16
4261	10A5	Alarm 7 - Register	INT16
4262	10A6	Alarm 7 - Threshold Type	INT16
4263	10A7	Alarm 7 - Units Selection	INT16
4264	10A8	Alarm 7 - High Threshold	FLOAT
4266	10AA	Alarm 7 - Low Threshold	FLOAT
4268	10AC	Alarm 7 - Dead Band	FLOAT

Alarm Configuration		Register Size: 16-Bit	
Register (Decimal)	Register (Hex)	Description	Data Type
4270	10AE	Alarm 7 - Hold-Off Period	INT16
4271	10AF	Alarm 8 - Register	INT16
4272	10B0	Alarm 8 - Threshold Type	INT16
4273	10B1	Alarm 8 - Units Selection	INT16
4274	10B2	Alarm 8 - High Threshold	FLOAT
4276	10B4	Alarm 8 - Low Threshold	FLOAT
4278	10B6	Alarm 8 - Dead Band	FLOAT
4280	10B8	Alarm 8 - Hold-Off Period	INT16

Archive Configuration		Register Size: 16-Bit	
Register (Decimal)	Register (Hex)	Description	Data Type
4300	10CC	Contract Hour	INT16
4301	10CD	Interval Period	INT16
4302	10CE	Archive1 - Register	INT16
4303	10CF	Archive2 - Register	INT16
4304	10D0	Archive3 - Register	INT16
4305	10D1	Archive4 - Register	INT16
4306	10D2	Archive5 - Register	INT16
4307	10D3	Archive6 - Register	INT16
4308	10D4	Archive7 - Register	INT16
4309	10D5	Archive8 - Register	INT16

Network Settings		Register Size: 16-Bit	
Register (Decimal)	Register (Hex)	Description	Data Type
4900	1324	Network Options	INT16
4901	1325	Ethernet VLAN ID	INT16
4902	1326	IPv4 MTU	INT16
4903	1327	IPv4 Address	INT32
4905	1329	IPv4 Subnet Mask	INT32
4907	132B	IPv4 Default Gateway	INT32
4909	132D	IPv4 Primary DNS	INT32
4911	132F	IPv4 Secondary DNS	INT32

HOLDING REGISTERS 7000 SERIES

The Holding Register Maps beginning at register 7000 are provided for NUFLO MC-III compatibility. For new projects, the Holding Registers Ext at register 7200 provides additional functionality.

Holding Registers - Enron 32-bit			Register Size: 32-Bit
Register (Decimal)	Register (Hex)	Description	Data Type
7000	1B58	Interval Record Pointer	FLOAT
7001	1B59	Daily Record Pointer	FLOAT
7002	1B5A	User Event/Alarm Counter	FLOAT
7003	1B5B	Real Date	FLOAT
7004	1B5C	Real Time	FLOAT
7005	1B5D	T1 Grand Total	FLOAT
7006	1B5E	T1 Instantaneous Flow Rate	FLOAT
7007	1B5F	T1 Daily Total	FLOAT
7008	1B60	T1 Daily Run Time	FLOAT
7009	1B61	T1 Interval Total	FLOAT
7010	1B62	T1 Interval Run Time	FLOAT
7011	1B63	T1 Polling Total	FLOAT
7012	1B64	T1 Polling Run Time	FLOAT
7013	1B65	T1 Previous Day	FLOAT
7014	1B66	T1 Previous Day Run Time	FLOAT
7015	1B67	T1 Previous Hour	FLOAT
7016	1B68	T1 Previous Hour Run Time	FLOAT
7017	1B69	T1 Previous Polling Total	FLOAT
7018	1B6A	T1 Previous Polling Run Time	FLOAT
7019	1B6B	T1 Polling Index	FLOAT
7020	1B6C	Internal Temperature (degC)	FLOAT
7021	1B6D	Supply Voltage (V)	FLOAT
7022	1B6E	Battery Voltage (V)	FLOAT
7023	1B6F	T1 Grand Total (GAL)	FLOAT
7024	1B70	T1 Inst. Flow Rate (GAL/sec)	FLOAT
7025	1B71	T1 Daily Total (GAL)	FLOAT
7026	1B72	T1 Daily Run Time (GAL)	FLOAT
7027	1B73	T1 Interval Total (GAL)	FLOAT
7028	1B74	T1 Interval Run Time (GAL)	FLOAT
7029	1B75	T1 Polling Total (GAL)	FLOAT
7030	1B76	T1 Polling Run Time (GAL)	FLOAT
7031	1B77	T1 Previous Day Total (GAL)	FLOAT
7032	1B78	T1 Previous Day Run Time (GAL)	FLOAT
7033	1B79	T1 Previous Hour Total (GAL)	FLOAT
7034	1B7A	T1 Previous Hour Run Time (GAL)	FLOAT

Holding Registers - Enron 32-bit			Register Size: 32-Bit
Register (Decimal)	Register (Hex)	Description	Data Type
7035	1B7B	T1 Previous Polling Total (GAL)	FLOAT
7036	1B7C	T1 Previous Polling Run Time (GAL)	FLOAT
7037	1B7D	T1 Polling Index (GAL)	FLOAT
7038	1B7E	PO1 Pulses	FLOAT
7039	1B7F	AO1 Output Current (mA)	FLOAT
7040	1B80	T1 Active K-Factor	FLOAT
7041	1B81	T1 Incremental Accum (GAL)	FLOAT
7042	1B82	T1 Frequency (Hz)	FLOAT
7043	1B83	T1 Active Meter-Factor	FLOAT
7044	1B84	T1 Monthly Total	FLOAT
7045	1B85	T1 Monthly Run Time	FLOAT
7046	1B86	T1 Previous Month Total	FLOAT
7047	1B87	T1 Previous Month Run Time	FLOAT
7048	1B88	T1 Monthly Total (GAL)	FLOAT
7049	1B89	T1 Monthly Run Time (GAL)	FLOAT
7050	1B8A	T1 Previous Month Total (GAL)	FLOAT
7051	1B8B	T1 Previous Month Run Time (GAL)	FLOAT

Holding Registers Ext - Enron 32-bit			Register Size: 32-Bit
Register (Decimal)	Register (Hex)	Description	Data Type
7200	1C20	Interval Record Pointer	FLOAT
7201	1C21	Daily Record Pointer	FLOAT
7202	1C22	User Event Counter	FLOAT
7203	1C23	Real Date	FLOAT
7204	1C24	Real Time	FLOAT
7205	1C25	Polling Index	FLOAT
7206	1C26	T1 Grand Total	FLOAT
7207	1C27	T1 Instantaneous Flow Rate	FLOAT
7208	1C28	T1 Daily Total	FLOAT
7209	1C29	T1 Interval Total	FLOAT
7210	1C2A	T1 Monthly Total	FLOAT
7211	1C2B	T1 Polling Total	FLOAT
7212	1C2C	T1 Daily Run Time	FLOAT
7213	1C2D	T1 Interval Run Time	FLOAT
7214	1C2E	T1 Monthly Run Time	FLOAT
7215	1C2F	T1 Polling Run Time	FLOAT
7216	1C30	T1 Previous Day Total	FLOAT
7217	1C31	T1 Previous Hour Total	FLOAT

Holding Registers Ext - Enron 32-bit			Register Size: 32-Bit
Register (Decimal)	Register (Hex)	Description	Data Type
7218	1C32	T1 Previous Month Total	FLOAT
7219	1C33	T1 Previous Polling Total	FLOAT
7220	1C34	T1 Previous Day Run Time	FLOAT
7221	1C35	T1 Previous Hour Run Time	FLOAT
7222	1C36	T1 Previous Month Run Time	FLOAT
7223	1C37	T1 Previous Polling Run Time	FLOAT
7224	1C38	T1 Grand Total (GAL)	FLOAT
7225	1C39	T1 Inst. Flow Rate (GAL/sec)	FLOAT
7226	1C3A	T1 Daily Total (GAL)	FLOAT
7227	1C3B	T1 Interval Total (GAL)	FLOAT
7228	1C3C	T1 Monthly Total (GAL)	FLOAT
7229	1C3D	T1 Polling Total (GAL)	FLOAT
7230	1C3E	T1 Daily Run Time (GAL)	FLOAT
7231	1C3F	T1 Interval Run Time (GAL)	FLOAT
7232	1C40	T1 Monthly Run Time (GAL)	FLOAT
7233	1C41	T1 Polling Run Time (GAL)	FLOAT
7234	1C42	T1 Previous Day Total (GAL)	FLOAT
7235	1C43	T1 Previous Hour Total (GAL)	FLOAT
7236	1C44	T1 Previous Month Total (GAL)	FLOAT
7237	1C45	T1 Previous Polling Total (GAL)	FLOAT
7238	1C46	T1 Previous Day Run Time (GAL)	FLOAT
7239	1C47	T1 Previous Hour Run Time (GAL)	FLOAT
7240	1C48	T1 Previous Month Run Time (GAL)	FLOAT
7241	1C49	T1 Previous Polling Run Time (GAL)	FLOAT
7242	1C4A	T1 Frequency (Hz)	FLOAT
7243	1C4B	T1 Active K-Factor	FLOAT
7244	1C4C	T1 Active Meter-Factor	FLOAT
7245	1C4D	T1 Incremental Accum (GAL)	FLOAT
7246	1C4E	Internal Temperature (degC)	FLOAT
7247	1C4F	Power - Supply Voltage	FLOAT
7248	1C50	Power - Battery Voltage 1	FLOAT
7249	1C51	Power - Battery Percent 1	FLOAT
7250	1C52	Power - Battery Runtime 1	FLOAT
7251	1C53	Power - Battery Voltage 2	FLOAT
7252	1C54	Power - Battery Percent 2	FLOAT
7253	1C55	Power - Battery Runtime 2	FLOAT
7254	1C56	Power - Expansion Voltage	FLOAT
7255	1C57	Power - Active Power Source	FLOAT

Holding Registers Ext - Enron 32-bit			Register Size: 32-Bit
Register (Decimal)	Register (Hex)	Description	Data Type
7256	1C58	Power - Digital Voltage	FLOAT
7257	1C59	Power - Coin Voltage	FLOAT
7258	1C5A	Digital Output 1 - Pulses	FLOAT
7259	1C5B	Digital Output 1 - Output State	FLOAT
7260	1C5C	Digital Output 2 - Pulses	FLOAT
7261	1C5D	Digital Output 2 - Output State	FLOAT
7262	1C5E	HART Loop Voltage	FLOAT
7263	1C5F	HART Loop Current	FLOAT
7264	1C60	HART Item 1 - Output Value	FLOAT
7265	1C61	HART Item 2 - Output Value	FLOAT
7266	1C62	HART Item 3 - Output Value	FLOAT
7267	1C63	HART Item 4 - Output Value	FLOAT
7268	1C64	Events Daily	FLOAT
7269	1C65	Events Interval	FLOAT
7270	1C66	Events Monthly	FLOAT
7271	1C67	Events Polling	FLOAT
7272	1C68	Events Previous Day	FLOAT
7273	1C69	Events Previous Hour	FLOAT
7274	1C6A	Events Previous Month	FLOAT
7275	1C6B	Events Previous Polling	FLOAT

BASE UNITS/CONFIGURED UNITS

The holding register area provides two blocks of registers. The first block is based on the *configured* units of measurement. The configured volume units will follow the settings in the Volume Unit register (2000). The configured rate units will follow the settings in the Rate Volume units (2002) and the Time-Base register (2003).

For example, if the settings for the volume unit is 2 (BBL), all of the total parameters such as Grand Total (17011), Daily Total (17015), etc. will be in terms of barrels. The values in these registers will change if the user changes the units of measurement that appear on the LCD.

The second block is in terms of *base* units. These register values are independent of the configured volume units in the Volume Unit, Rate Volume Unit, and Time-Base registers. For base units, the time base is always measured in seconds, and the volume and rate volume units are measured in gallons. If the x1000 unit is enabled, the volume unit is gallons times 1000.

CONVERSION FACTORS

For base units, the volume unit and rate volume unit is measured in gallons. To convert gallons to another unit of measure, use the conversion factors listed in the table below. For example, to convert gallons to barrels, multiply gallons times 0.02380952381.

To Convert From Gallons To...	Multiply By...
No units	1.00000000000
Barrels	0.02380952381
Cubic meters	0.00378541178
Cubic feet	0.13368055556
Liters	3.78541178400

For base units, the rate values are in terms of rate per second. To convert to another time base unit, use the conversion factors listed in the table below. For example, to convert Gallons per Second (a base unit) to Gallons per Day, multiply by 86400.

To Convert From Seconds To...	Multiply By...
Seconds	1
Minutes	60
Hour	3600
Day	86400

POLLING REGISTERS

The MC Synergy EXP device stores the volume accumulated since the last polling sequence in a set of polling registers (17023). In addition, the instrument monitors the number of seconds of flow time in each polling interval (17025). There is also an index to the number of polls requested (17039). Polling registers are commonly used in applications such as batching.

The polling sequence is started by writing to the Control Register. Writing the Control Register 1 (70) with a value of 20000 decimal transfers the polling total (17023) and polling run time (17025) to the previous polling total (17035) and previous polling run time (17037) registers, increments the polling index (17039) register and resets the polling total and polling run time registers.

The polling sequence can also be initiated with a Reset Input command. For details, see the MC Synergy software manual.

INTERVAL/DAILY/EVENT POINTER (REGISTERS 17001 THROUGH 17006)

These registers provide an index of the last record that was stored in the log data. These values start at 1 and increment with each newly created log. When the maximum number of records is reached, the pointer resets at 1 and starts incrementing again.

REAL DATE (REGISTERS 17007, 17008)

This register is a floating-point representation of the date, formatted as MMDDYY. For example, a value of 91023 represents September 10, 2023.

REAL TIME (REGISTERS 17009, 17010)

This register is a floating-point representation of time, formatted as HH:MM:SS. For example, a value of 180205 represents 6:02:05 PM.

TOTALS

The instrument provides a Grand Total, Monthly Total, Daily Total, Interval Total, and a Polling Total. It also provides Previous Day Total, Previous Hour Total, and Previous Polling Total. This data is available in terms of configured units and base units. Refer to [Base Units/Configured Units, page C-23](#), for details. The totals are available in multiple register maps starting: 7000, 7200, 8000, 8200, and 17001. The monthly total is provided in register maps starting: 7200 and 8200.

ACTIVE K-FACTOR (REGISTER 8286)

This register represents the K-factor that was used for the most recent calculation interval. This number is calculated based on the factor type (register 2300), the instantaneous frequency from the flowmeter, calibration frequencies (registers 2306 through 2328), and calibration factors (registers 2330 through 2352). The unit of measurement for this register is pulses per configured factor unit.

ACTIVE METER FACTOR (REGISTER 8288)

This register represents the meter factor that was used for the most recent calculation interval. This number is calculated based on the factor type (register 2354), the instantaneous frequency from the flowmeter, the meter factor frequencies (registers 2360 through 2382), and meter factors (registers 2384 through 2402). The unit of measurement for this register is dimensionless.

HOLDING REGISTERS 8000 SERIES

The Holding Register Map beginning at register 8000 is provided for NUFLO MC-III compatibility. For new projects, the Holding Registers Ext at register 8200 provides additional functionality.

Holding Registers			Register Size: 16-Bit
Register (Decimal)	Register (Hex)	Description	Data Type
8000	1F40	Interval Record Pointer	FLOAT
8002	1F42	Daily Record Pointer	FLOAT
8004	1F44	User Event/Alarm Counter	FLOAT
8006	1F46	Real Date	FLOAT
8008	1F48	Real Time	FLOAT
8010	1F4A	T1 Grand Total	FLOAT
8012	1F4C	T1 Instantaneous Flow Rate	FLOAT
8014	1F4E	T1 Daily Total	FLOAT
8016	1F50	T1 Daily Run Time	FLOAT
8018	1F52	T1 Interval Total	FLOAT
8020	1F54	T1 Interval Run Time	FLOAT
8022	1F56	T1 Polling Total	FLOAT
8024	1F58	T1 Polling Run Time	FLOAT
8026	1F5A	T1 Previous Day	FLOAT
8028	1F5C	T1 Previous Day Run Time	FLOAT
8030	1F5E	T1 Previous Hour	FLOAT
8032	1F60	T1 Previous Hour Run Time	FLOAT
8034	1F62	T1 Previous Polling Total	FLOAT

Holding Registers			Register Size: 16-Bit
Register (Decimal)	Register (Hex)	Description	Data Type
8036	1F64	T1 Previous Polling Run Time	FLOAT
8038	1F66	T1 Polling Index	FLOAT
8040	1F68	Internal Temperature (degC)	FLOAT
8042	1F6A	Supply Voltage (V)	FLOAT
8044	1F6C	Battery Voltage (V)	FLOAT
8046	1F6E	T1 Grand Total (GAL)	FLOAT
8048	1F70	T1 Inst. Flow Rate (GAL/sec)	FLOAT
8050	1F72	T1 Daily Total (GAL)	FLOAT
8052	1F74	T1 Daily Run Time (GAL)	FLOAT
8054	1F76	T1 Interval Total (GAL)	FLOAT
8056	1F78	T1 Interval Run Time (GAL)	FLOAT
8058	1F7A	T1 Polling Total (GAL)	FLOAT
8060	1F7C	T1 Polling Run Time (GAL)	FLOAT
8062	1F7E	T1 Previous Day Total (GAL)	FLOAT
8064	1F80	T1 Previous Day Run Time (GAL)	FLOAT
8066	1F82	T1 Previous Hour Total (GAL)	FLOAT
8068	1F84	T1 Previous Hour Run Time (GAL)	FLOAT
8070	1F86	T1 Previous Polling Total (GAL)	FLOAT
8072	1F88	T1 Previous Polling Run Time (GAL)	FLOAT
8074	1F8A	T1 Polling Index (GAL)	FLOAT
8076	1F8C	PO1 Pulses	FLOAT
8078	1F8E	AO1 Output Current (mA)	FLOAT
8080	1F90	T1 Active K-Factor	FLOAT
8082	1F92	T1 Incremental Accum (GAL)	FLOAT
8084	1F94	T1 Frequency (Hz)	FLOAT
8086	1F96	T1 Active Meter-Factor	FLOAT
8088	1F98	T1 Monthly Total	FLOAT
8090	1F9A	T1 Monthly Run Time	FLOAT
8092	1F9C	T1 Previous Month Total	FLOAT
8094	1F9E	T1 Previous Month Run Time	FLOAT
8096	1FA0	T1 Monthly Total (GAL)	FLOAT
8098	1FA2	T1 Monthly Run Time (GAL)	FLOAT
8100	1FA4	T1 Previous Month Total (GAL)	FLOAT
8102	1FA6	T1 Previous Month Run Time (GAL)	FLOAT

Holding Registers Ext			Register Size: 16-Bit
Register (Decimal)	Register (Hex)	Description	Data Type
8200	2008	Interval Record Pointer	FLOAT
8202	200A	Daily Record Pointer	FLOAT
8204	200C	User Event/Alarm Counter	FLOAT
8206	200E	Real Date	FLOAT
8208	2010	Real Time	FLOAT
8210	2012	Polling Index	FLOAT
8212	2014	T1 Grand Total	FLOAT
8214	2016	T1 Instantaneous Flow Rate	FLOAT
8216	2018	T1 Daily Total	FLOAT
8218	201A	T1 Interval Total	FLOAT
8220	201C	T1 Monthly Total	FLOAT
8222	201E	T1 Polling Total	FLOAT
8224	2020	T1 Daily Run Time	FLOAT
8226	2022	T1 Interval Run Time	FLOAT
8228	2024	T1 Monthly Run Time	FLOAT
8230	2026	T1 Polling Run Time	FLOAT
8232	2028	T1 Previous Day Total	FLOAT
8234	202A	T1 Previous Hour Total	FLOAT
8236	202C	T1 Previous Month Total	FLOAT
8238	202E	T1 Previous Polling Total	FLOAT
8240	2030	T1 Previous Day Run Time	FLOAT
8242	2032	T1 Previous Hour Run Time	FLOAT
8244	2034	T1 Previous Month Run Time	FLOAT
8246	2036	T1 Previous Polling Run Time	FLOAT
8248	2038	T1 Grand Total (GAL)	FLOAT
8250	203A	T1 Inst. Flow Rate (GAL/sec)	FLOAT
8252	203C	T1 Daily Total (GAL)	FLOAT
8254	203E	T1 Interval Total (GAL)	FLOAT
8256	2040	T1 Monthly Total (GAL)	FLOAT
8258	2042	T1 Polling Total (GAL)	FLOAT
8260	2044	T1 Daily Run Time (GAL)	FLOAT
8262	2046	T1 Interval Run Time (GAL)	FLOAT
8264	2048	T1 Monthly Run Time (GAL)	FLOAT
8266	204A	T1 Polling Run Time (GAL)	FLOAT
8268	204C	T1 Previous Day Total (GAL)	FLOAT
8270	204E	T1 Previous Hour Total (GAL)	FLOAT
8272	2050	T1 Previous Month Total (GAL)	FLOAT
8274	2052	T1 Previous Polling Total (GAL)	FLOAT

Holding Registers Ext			Register Size: 16-Bit
Register (Decimal)	Register (Hex)	Description	Data Type
8276	2054	T1 Previous Day Run Time (GAL)	FLOAT
8278	2056	T1 Previous Hour Run Time (GAL)	FLOAT
8280	2058	T1 Previous Month Run Time (GAL)	FLOAT
8282	205A	T1 Previous Polling Run Time (GAL)	FLOAT
8284	205C	T1 Frequency (Hz)	FLOAT
8286	205E	T1 Active K-Factor	FLOAT
8288	2060	T1 Active Meter-Factor	FLOAT
8290	2062	T1 Incremental Accum (GAL)	FLOAT
8292	2064	Internal Temperature (degC)	FLOAT
8294	2066	Power - Supply Voltage	FLOAT
8296	2068	Power - Battery Voltage 1	FLOAT
8298	206A	Power - Battery Percent 1	FLOAT
8300	206C	Power - Battery Runtime 1	FLOAT
8302	206E	Power - Battery Voltage 2	FLOAT
8304	2070	Power - Battery Percent 2	FLOAT
8306	2072	Power - Battery Runtime 2	FLOAT
8308	2074	Power - Expansion Voltage	FLOAT
8310	2076	Power - Active Power Source	FLOAT
8312	2078	Power - Digital Voltage	FLOAT
8314	207A	Power - Coin Voltage	FLOAT
8316	207C	Digital Output 1 - Pulses	FLOAT
8318	207E	Digital Output 1 - Output State	FLOAT
8320	2080	Digital Output 2 - Pulses	FLOAT
8322	2082	Digital Output 2 - Output State	FLOAT
8324	2084	HART Loop Voltage	FLOAT
8326	2086	HART Loop Current	FLOAT
8328	2088	HART Item 1 - Output Value	FLOAT
8330	208A	HART Item 2 - Output Value	FLOAT
8332	208C	HART Item 3 - Output Value	FLOAT
8334	208E	HART Item 4 - Output Value	FLOAT
8336	2090	Events Daily	FLOAT
8338	2092	Events Interval	FLOAT
8340	2094	Events Monthly	FLOAT
8342	2096	Events Polling	FLOAT
8344	2098	Events Previous Day	FLOAT
8346	209A	Events Previous Hour	FLOAT
8348	209C	Events Previous Month	FLOAT
8350	209E	Events Previous Polling	FLOAT

Holding Registers - System Alarms			Register Size: 16-Bit
Register (Decimal)	Register (Hex)	Description	Data Type
8400	20D0	System Alarms - Has Alarmed Instantaneous	INT16
8401	20D1	System Alarms - Has Alarmed Acknowledged	INT16
8402	20D2	System Alarms - Has Alarmed Day	INT16
8403	20D3	System Alarms - Has Alarmed Interval	INT16
8404	20D4	System Alarms - Has Alarmed Month	INT16
8405	20D5	System Alarms - Has Alarmed Polling	INT16
8406	20D6	System Alarms - Has Alarmed Previous Acknowledged	INT16
8407	20D7	System Alarms - Has Alarmed Previous Day	INT16
8408	20D8	System Alarms - Has Alarmed Previous Interval	INT16
8409	20D9	System Alarms - Has Alarmed Previous Month	INT16
8410	20DA	System Alarms - Has Alarmed Previous Polling	INT16
8411	20DB	System Alarm Time Not Entered - Status	INT16
8412	20DC	System Alarm Time Not Entered - Current Value	FLOAT
8414	20DE	System Alarm Supply Voltage - Status	INT16
8415	20DF	System Alarm Supply Voltage - Current Value	FLOAT
8417	20E1	System Alarm Expansion Voltage - Status	INT16
8418	20E2	System Alarm Expansion Voltage - Current Value	FLOAT
8420	20E4	System Alarm BAT1 Voltage - Status	INT16
8421	20E5	System Alarm BAT1 Voltage - Current Value	FLOAT
8423	20E7	System Alarm BAT1 Percent - Status	INT16
8424	20E8	System Alarm BAT1 Percent - Current Value	FLOAT
8426	20EA	System Alarm BAT2 Voltage - Status	INT16
8427	20EB	System Alarm BAT2 Voltage - Current Value	FLOAT
8429	20ED	System Alarm BAT2 Percent - Status	INT16
8430	20EE	System Alarm BAT2 Percent - Current Value	FLOAT

Holding Registers - Turbine Alarms			Register Size: 16-Bit
Register (Decimal)	Register (Hex)	Description	Data Type
8500	2134	Turbine Alarms - Has Alarmed Instantaneous	INT16
8501	2135	Turbine Alarms - Has Alarmed Acknowledged	INT16
8502	2136	Turbine Alarms - Has Alarmed Day	INT16
8503	2137	Turbine Alarms - Has Alarmed Interval	INT16
8504	2138	Turbine Alarms - Has Alarmed Month	INT16
8505	2139	Turbine Alarms - Has Alarmed Polling	INT16
8506	213A	Turbine Alarms - Has Alarmed Previous Acknowledged	INT16
8507	213B	Turbine Alarms - Has Alarmed Previous Day	INT16
8508	213C	Turbine Alarms - Has Alarmed Previous Interval	INT16
8509	213D	Turbine Alarms - Has Alarmed Previous Month	INT16

Holding Registers - Turbine Alarms			Register Size: 16-Bit
Register (Decimal)	Register (Hex)	Description	Data Type
8510	213E	Turbine Alarms - Has Alarmed Previous Polling	INT16
8511	213F	Turbine Alarm T1 LowLow Flow - Status	INT16
8512	2140	Turbine Alarm T1 LowLow Flow - Current Value	FLOAT
8514	2142	Turbine Alarm T1 Low Flow - Status	INT16
8515	2143	Turbine Alarm T1 Low Flow - Current Value	FLOAT
8517	2145	Turbine Alarm T1 High Flow - Status	INT16
8518	2146	Turbine Alarm T1 High Flow - Current Value	FLOAT
8520	2148	Turbine Alarm T1 HighHigh Flow - Status	INT16
8521	2149	Turbine Alarm T1 HighHigh Flow - Current Value	FLOAT
8523	214B	Turbine Alarm T1 Flow Stability Warning- Status	INT16
8524	214C	Turbine Alarm T1 Flow Stability Warning - Current Value	FLOAT
8526	214E	Turbine Alarm T1 Kfactor Error - Status	INT16
8527	214F	Turbine Alarm T1 Kfactor Error - Current Value	FLOAT
8529	2151	Turbine Alarm T1 Mfactor Error - Status	INT16
8530	2152	Turbine Alarm T1 Mfactor Error - Current Value	FLOAT
8532	2154	Turbine Alarm T1 Bent Blade - Status	INT16
8533	2155	Reserved	FLOAT
8535	2157	Turbine Alarm T1 Missing Blade - Status	INT16
8536	2158	Reserved	FLOAT
8538	215A	Turbine Alarm T1 Erratic Signal - Status	INT16
8539	215B	Reserved	FLOAT
8541	215D	Turbine Alarm T1 Replace Kit - Status	INT16
8542	215E	Turbine Alarm T1 Replace Kit - Current Value	FLOAT

Holding Registers - User Alarms			Register Size: 16-Bit
Register (Decimal)	Register (Hex)	Description	Data Type
8600	2198	User Alarms - Has Alarmed Instantaneous	INT16
8601	2199	User Alarms - Has Alarmed Acknowledged	INT16
8602	219A	User Alarms - Has Alarmed Day	INT16
8603	219B	User Alarms - Has Alarmed Interval	INT16
8604	219C	User Alarms - Has Alarmed Month	INT16
8605	219D	User Alarms - Has Alarmed Polling	INT16
8606	219E	User Alarms - Has Alarmed Previous Acknowledged	INT16
8607	219F	User Alarms - Has Alarmed Previous Day	INT16
8608	21A0	User Alarms - Has Alarmed Previous Interval	INT16
8609	21A1	User Alarms - Has Alarmed Previous Month	INT16
8610	21A2	User Alarms - Has Alarmed Previous Polling	INT16
8611	21A3	User Alarms - Tag Error	INT16

Holding Registers - User Alarms			Register Size: 16-Bit
Register (Decimal)	Register (Hex)	Description	Data Type
8612	21A4	User Alarm 1 - Status	INT16
8613	21A5	User Alarm 1 - Current Value	FLOAT
8615	21A7	User Alarm 2 - Status	INT16
8616	21A8	User Alarm 2 - Current Value	FLOAT
8618	21AA	User Alarm 3 - Status	INT16
8619	21AB	User Alarm 3 - Current Value	FLOAT
8621	21AD	User Alarm 4 - Status	INT16
8622	21AE	User Alarm 4 - Current Value	FLOAT
8624	21B0	User Alarm 5 - Status	INT16
8625	21B1	User Alarm 5 - Current Value	FLOAT
8627	21B3	User Alarm 6 - Status	INT16
8628	21B4	User Alarm 6 - Current Value	FLOAT
8630	21B6	User Alarm 7 - Status	INT16
8631	21B7	User Alarm 7 - Current Value	FLOAT
8633	21B9	User Alarm 8 - Status	INT16
8634	21BA	User Alarm 8 - Current Value	FLOAT

Holding Registers - Serial Status			Register Size: 16-Bit
Register (Decimal)	Register (Hex)	Description	Data Type
8800	2260	Port 0 Status	INT32
8802	2262	Port 0 Rx Byte Count	INT32
8804	2264	Port 0 Tx Byte Count	INT32
8806	2266	Port 0 Rx Packet Count	INT32
8808	2268	Port 0 Tx Packet Count	INT32
8810	226A	Port 0 Framing Errors	INT32
8812	226C	Port 0 Parity Errors	INT32
8814	226E	Port 0 Overrun Errors	INT32
8816	2270	Port 0 Break Errors	INT32
8818	2272	Port 1 Status	INT32
8820	2274	Port 1 Rx Byte Count	INT32
8822	2276	Port 1 Tx Byte Count	INT32
8824	2278	Port 1 Rx Packet Count	INT32
8826	227A	Port 1 Tx Packet Count	INT32
8828	227C	Port 1 Framing Errors	INT32
8830	227E	Port 1 Parity Errors	INT32
8832	2280	Port 1 Overrun Errors	INT32
8834	2282	Port 1 Break Errors	INT32
8836	2284	TCP Port 1 Status	INT32

Holding Registers - Serial Status			Register Size: 16-Bit
Register (Decimal)	Register (Hex)	Description	Data Type
8838	2286	TCP Port 1 Rx Byte Count	INT32
8840	2288	TCP Port 1 Tx Byte Count	INT32
8842	228A	TCP Port 1 Rx Packet Count	INT32
8844	228C	TCP Port 1 Tx Packet Count	INT32
8846	228E	TCP Port 2 Status	INT32
8848	2290	TCP Port 2 Rx Byte Count	INT32
8850	2292	TCP Port 2 Tx Byte Count	INT32
8852	2294	TCP Port 2 Rx Packet Count	INT32
8854	2296	TCP Port 2 Tx Packet Count	INT32

Holding Registers - Network Status			Register Size: 16-Bit
Register (Decimal)	Register (Hex)	Description	Data Type
8900	22C4	Ethernet MAC Address Low	INT32
8902	22C6	Ethernet MAC Address High	INT32
8904	22C8	Ethernet VLAN Identifier	INT16
8905	22C9	IPv4 Maximum Transmission Unit	INT16
8906	22CA	IPv4 Address	INT32
8908	22CC	IPv4 Subnet mask	INT32
8910	22CE	IPv4 Default Gateway	INT32
8912	22D0	IPv4 Primary DNS	INT32
8914	22D2	IPv4 Secondary DNS	INT32
8916	22D4	Ethernet Link Status	INT16

HOLDING REGISTERS 17000 SERIES

The Holding Register Maps beginning at register 17001 are provided for NUFLO MC-III compatibility. For new projects, the Holding Registers Ext at register 8200 provides additional functionality.

Holding Registers - MC-III			Register Size: 16-Bit
Register (Decimal)	Register (Hex)	Description	Data Type
17001	4269	Interval Record Pointer	FLOAT
17003	426B	Daily Record Pointer	FLOAT
17005	426D	User Event/Alarm Counter	FLOAT
17007	426F	Real Date	FLOAT
17009	4271	Real Time	FLOAT
17011	4273	T1 Grand Total	FLOAT
17013	4275	T1 Instantaneous Flow Rate	FLOAT
17015	4277	T1 Daily Total	FLOAT
17017	4279	T1 Daily Run Time	FLOAT

Holding Registers - MC-III			Register Size: 16-Bit
Register (Decimal)	Register (Hex)	Description	Data Type
17019	427B	T1 Interval Total	FLOAT
17021	427D	T1 Interval Run Time	FLOAT
17023	427F	T1 Polling Total	FLOAT
17025	4281	T1 Polling Run Time	FLOAT
17027	4283	T1 Previous Day	FLOAT
17029	4285	T1 Previous Day Run Time	FLOAT
17031	4287	T1 Previous Hour	FLOAT
17033	4289	T1 Previous Hour Run Time	FLOAT
17035	428B	T1 Previous Polling Total	FLOAT
17037	428D	T1 Previous Polling Run Time	FLOAT
17039	428F	T1 Polling Index	FLOAT
17041	4291	Internal Temperature (degC)	FLOAT
17043	4293	Supply Voltage (V)	FLOAT
17045	4295	Battery Voltage (V)	FLOAT
17047	4297	T1 Grand Total (GAL)	FLOAT
17049	4299	T1 Inst. Flow Rate (GAL/sec)	FLOAT
17051	429B	T1 Daily Total (GAL)	FLOAT
17053	429D	T1 Daily Run Time (GAL)	FLOAT
17055	429F	T1 Interval Total (GAL)	FLOAT
17057	42A1	T1 Interval Run Time (GAL)	FLOAT
17059	42A3	T1 Polling Total (GAL)	FLOAT
17061	42A5	T1 Polling Run Time (GAL)	FLOAT
17063	42A7	T1 Previous Day Total (GAL)	FLOAT
17065	42A9	T1 Previous Day Run Time (GAL)	FLOAT
17067	42AB	T1 Previous Hour Total (GAL)	FLOAT
17069	42AD	T1 Previous Hour Run Time (GAL)	FLOAT
17071	42AF	T1 Previous Polling Total (GAL)	FLOAT
17073	42B1	T1 Previous Polling Run Time (GAL)	FLOAT
17075	42B3	T1 Polling Index (GAL)	FLOAT
17077	42B5	PO1 Pulses	FLOAT
17079	42B7	AO1 Output Current (mA)	FLOAT
17081	42B9	T1 Active K-Factor	FLOAT
17083	42BB	T1 Incremental Accum (GAL)	FLOAT
17085	42BD	T1 Frequency (Hz)	FLOAT
17087	42BF	T1 Active Meter-Factor	FLOAT
17089	42C1	T1 Monthly Total	FLOAT
17091	42C3	T1 Monthly Run Time	FLOAT
17093	42C5	T1 Previous Month Total	FLOAT

Holding Registers - MC-III			Register Size: 16-Bit
Register (Decimal)	Register (Hex)	Description	Data Type
17095	42C7	T1 Previous Month Run Time	FLOAT
17097	42C9	T1 Monthly Total (GAL)	FLOAT
17099	42CB	T1 Monthly Run Time (GAL)	FLOAT
17101	42CD	T1 Previous Month Total (GAL)	FLOAT
17103	42CF	T1 Previous Month Run Time (GAL)	FLOAT

COMMAND REGISTERS

The Command Registers (See Register 70) allow specific functions to be implemented via the communications ports. The following table shows the values to be written to the command registers to implement the desired function.

Note Administration rights are not required to access these registers.

Command	Argument 1	Argument 2	Argument 3	Argument 4	Argument 5	Description
Preset Meter Kit	30301	Object	Value	NA	NA	Presets the Life time counter on the turbine meter to a user-specified number of days.
		Object: 0 to preset Value = Number of Days to preload.				
Soft Reset	40040	NA	NA	NA	NA	Cause device to reset.
Set Real Date	10001	Year	Month	Day	NA	Updates the date of the internal real-time clock.
		Year: Gregorian year in decimal. ie. 2015. 0 = Do not change Month: 1 = January, 12 = December, 0 = Do not change Day: Day of Month. 1 - 31, 0 = Do not change				
Set Real Time	10002	Hour	Minute	Second	NA	Updates the time of the internal real-time clock.
		Hour: 0 - 23, (>= 24) = Do not change Minute: 0 - 59, (>= 60) = Do not change Second: 0 - 59, (>= 60) = Do not change				
Publish Polling Records	20000	NA	NA	NA	NA	Causes the publishing of all Polling Registers to the Previous Polling and increments the Polling Index.
Create Partial Records	20020	NA	NA	NA	NA	Create Archive Partial Records.
Acknowledge Device Alarms	5000	NA	NA	NA	NA	Clears the Unacknowledged Device Alarms register.
Reset Port Stats	6000	Port	NA	NA	NA	Clears the statistics counters for a target port.
		Port: 0 = All 1 = SP1, 2 = SP2, 3 = TCP				
Reset All Grand Totals	30000	NA	NA	NA	NA	Resets All Grand Totals.
Reset Grand Total	30001	Object	NA	NA	NA	Resets Pulse Input Grand Totals in the Flow Computer Manager.
		Object: 0 = All, 1 = PI1, 2 = PI2				

Command	Argument 1	Argument 2	Argument 3	Argument 4	Argument 5	Description
Reset Meter Kit	30300	Object	NA	NA	NA	Resets the Life time counter on the turbine meter.
		Object: 0 = All, 1 = PI1, 2 = PI2				
Clear Turbine Health	30307	Object	NA	NA	NA	Clears all recorded turbine health events. Also performed with Reset Meter Kit.
		Object: 0 = All, 1 = PI1, 2 = PI2				

LOG DATA

The MC Synergy provides Enron Modbus compliant downloads. For detailed instructions on downloading interval, daily and event data, refer to Specifications and Requirements for an Electronic Flow Measurement Remote Terminal Unit for Enron Corp.

The following registers are used for interval, daily and event log registers. Interval and daily records comprise 11 values (registers). See the [Enron Interval/Daily Record Format, page C-35](#). Note that event records are downloaded one at a time.

The MC Synergy archive consists of seven configurable parameters. The archive is configured using the PC program.

Enron Registers				
Register (Decimal)	Register (Hex)	Description	Data Type	Access
32	0020	Enron Modbus Event Log Register	Refer to Enron Event Record Format	RO
700	02BC	Enron Modbus Interval Log	Refer to Enron Interval/Daily Record Format	RO
701	02BD	Enron Modbus Daily Log	Refer to Enron Interval/Daily Record Format	RO
7000	1B58	Interval Pointer [1 to 768]	FLOAT	RO
7001	1B59	Daily Pointer [1 to 384]	FLOAT	RO
7002	1B5A	User Event/Alarm Counter [1 to 1536]	FLOAT	RO

Enron Interval/Daily Record Format	
Parameter	Data Type
Date (MMDDYY)	FLOAT
Time (HH:MM:SS)	FLOAT
Archive Parameter 1 (base units)	FLOAT
Archive Parameter 2 (base units)	FLOAT

Enron Interval/Daily Record Format	
Parameter	Data Type
Archive Parameter 3 (base units)	FLOAT
Archive Parameter 4 (base units)	FLOAT
Archive Parameter 5 (base units)	FLOAT
Archive Parameter 6 (base units)	FLOAT
Archive Parameter 7 (base units)	FLOAT
Device Status	FLOAT

Enron Event Record Format	
Parameter	Data Type
Status	INT16
Address	INT16
Time (HH:MM:SS)	FLOAT
Date (MMDDYY)	FLOAT
As-Found	FLOAT
As-Left	FLOAT

Appendix D—HART Communications

OVERVIEW

This chapter provides an overview of the MC Synergy HART Protocol implementation.

INTRODUCTION

The Sensia MC Synergy calculates and displays instantaneous flow rates and accumulated totals based on a turbine flowmeter input signal.

The Sensia MC Synergy flow transmitter complies with HART Protocol Revision 7.6. This document describes the device-specific features and documents the HART Protocol implementation.

DEVICE IDENTIFICATION

TABLE D.1—DEVICE IDENTIFICATION			
Manufacturer Name:	Sensia	Model Name(s):	NUFLO MC Synergy
Manufacture ID Code:	24759 (0060B7 Hex)	Device Type Code:	58504
HART Protocol Revision	7.6	Device Revision:	1
Number of Device Variables	14		
Physical Layers Supported	FSK		
Physical Device Category	Transmitter, Non-DC-isolated Bus Device		

HART COMMANDS

UNIVERSAL COMMANDS

Sensia supports all universal commands defined in revision 7 of the HART Communications Protocol Specification HFC-SPEC-13 and the Universal Command Specification HCF_SPEC-127, both maintained by the FieldComm Group.

The MC Synergy has been evaluated to comply with the Universal commands. Additional information is provided in the response message for commands 3, 9, and 48 as detailed in [Table D.2](#).

TABLE D.2—UNIVERSAL COMMANDS		
Command	Command Name	
3	Read Dynamic Variables and Loop Current	Response provides Loop Current, PV, SV, TV, QV, units (24 byte response).
9	Read Device Variables with Status	Responds with up to eight device variables. See Table D.5 .
48	Read Additional Device Status	Response provides specific status of user-defined alarms, turbine alarms, and system alarms. See Table D.10 .

COMMON PRACTICE COMMANDS

TABLE D.3—COMMON COMMANDS	
Command	Command Name
33	Read Device Variables
35	Write Primary Variable Range Values
36	Set Primary Variable Upper Range Value
37	Set Primary Variable Lower Range Value
40	Enter/Exit Fixed Current Mode
41	Perform Self-Test
42	Perform Device Reset
44	Write Primary Variable Units
45	Trim Loop Current Zero
46	Trim Loop Current Gain
50	Read Dynamic Variable Assignments
51	Write Dynamic Variable Assignments
53	Write Device Variable Units
54	Read Device Variable Information
59	Write Number of Response Preambles
71	Lock Device
72	Squawk
73	Find Device
76	Read Lock Device State
79	Write Device Variable
83	Reset Device Variable Trim
89	Set Real-Time Clock
90	Read Real-Time Clock
95	Read Device Communications Statistics
103	Write Burst Period
104	Write Burst Trigger
105	Read Burst Mode Configuration
107	Write Burst Device Variables
108	Write Burst Mode Command Number
109	Burst Mode Control

COMMAND 73 – FIND DEVICE

The command allows the MC Synergy to respond to this command only when it has been armed. For details on how to arm the device for this command, see [Section 3: Device Configuration via the Keypad, page 53](#).

DEVICE-SPECIFIC COMMANDS

TABLE D.4—DEVICE SPECIFIC COMMANDS		
Command	Command Name	Section Reference
128	Read Alarms	Command 128 – Read Alarms
129	Read Power	Command 129 – Read Power
130	Set Write Protection	Command 130 – Set Write Protection
131	Publish Polling Registers	Command 131 – Publish Polling Registers
132	Clear Grand Total	Command 132 – Clear Grand Total
133	Read K-Factor Configuration	Command 133 – Read K-Factor Configuration
134	Write K-Factor Configuration	Command 134 – Write K-Factor Configuration
135	Read Meter Factor Configuration	Command 135 – Read Meter Factor Configuration
136	Write Meter Factor Configuration	Command 136 – Write Meter Factor Configuration
137	Read Input Channel Configuration and Meter Characteristics	Command 137 – Read Input Channel Configuration and Meter Characteristics
138	Write Input Channel Configuration and Meter Characteristics	Command 138 – Write Input Channel Configuration and Meter Characteristics
139	Read Runtime Information	Command 139 – Read Runtime
140	Read Flow Rate Trim	Command 140 – Read Flow Rate Trim Digital to Analog Converter
141	Reset Analog Output Trim	Command 141 – Reset Analog Output Trim
142	Read Site / Well Name	Command 142 – Read Site / Well Name
143	Write Site / Well Name	Command 143 – Write Site / Well Name
144	Read Password Protection Status	Command 144 – Read Password Protection Status
145	Change Password	Command 145 – Change Password
146	Read Display Unit Configuration	Command 146 – Read Display Unit Configuration
147	Write Display Unit Configuration	Command 147 – Write Display Unit Configuration

BURST MODE

This Field Device supports Burst Mode on commands: 1, 2, 3, 9, 33, and 48.

CATCH DEVICE VARIABLE

This field device does not support Catch Device Variable.

VARIABLES AND STATUS

DEVICE VARIABLES

The MC Synergy EXP and WP totalizers support 14 device variables.

TABLE D.5—DEVICE VARIABLES			
Device Variable	Meaning	Description	Units
0	Instantaneous Flow Rate	Computed based on the Active Frequency and configuration	Table D.72
1	Grand Total	Accumulated quantity of flow from last reset of Grand total	Table D.73
2	Daily Total	Accumulated quantity of flow for current day based on contract hour	Table D.73
3	Interval Total	Accumulated quantity of flow for current interval of configured period	Table D.73
4	Polling Total	Accumulated quantity of flow from last published Polling Total	Table D.73
5	Previous Day Total	Previous record of Daily Total	Table D.73
6	Previous Interval Total	Previous record of Interval Total	Table D.73
7	Previous Polling Total	Previous record of Polling Total	Table D.73
8	Monthly Total	Accumulated quantity of flow for current month	Table D.73
9	Previous Monthly Total	Previous record of Monthly Total	Table D.73
10	Active Frequency	Computed based on average frequency over configured period.	Hz (Unit Code 38)
11	Active K-Factor	Computed based on the Active Frequency and configuration	Table D.74
12	Active Meter Factor	Computed based on the Active Frequency and configuration	No Unit
13	Internal Temperature	Measured on the microcontroller	Table D.75

DYNAMIC VARIABLES

This section details the dynamic variables for the MC Synergy family. Four dynamic variables are implemented. PV is always Instantaneous Flow Rate. The SV, TV and QV are mappable to any of the dynamic variables listed in [Table D.6, page D-5](#).

TABLE D.6—CONFIGURABLE DYNAMIC VARIABLES		
Dynamic Variables	Device Variable Number	Name
PV	0	Instantaneous Flow Rate (fixed)
SV TV QV	1	Grand Total
	2	Daily Total
	3	Interval Total
	4	Polling Total
	5	Previous Day Total
	6	Previous Interval Total
	7	Previous Polling Total

STATUS INFORMATION

TABLE D.7—DEVICE STATUS	
Device Specific Status	Bit
PV Out of Limit	0
Non PV Out of Limit	1
Loop Current Saturated	2
Loop Current Fixed	3
More Status Available	4
Cold Start	5
Configuration Changed	6
Device Malfunction	7

Bit 4 (“More Status Available”) is set whenever any alarm is detected. Universal Command #48 gives further detail.

TABLE D.8—EXTENDED DEVICE STATUS		
Device Specific Status	Bit	
Maintenance Required	0	The Field Device cannot predict in advance when maintenance will be required. This bit is set if a sensor break is detected.
Device Variable Alert	1	“Device Variable Alert” is set if the PV is out of limit.
Critical Power Failure	2	
Maintenance Required	3	
Out of Specification	4	
Critical Power Failure	5	
Undefined	6	
Undefined	7	

Universal Command #48 returns 10 bytes of data with the following status information:

TABLE D.9—COMMAND #48 RESPONSE DATA BYTES							
Byte	Type	Format	Description	Bit	Class	Device Status Bit Set	Extended Status Bit Set
0	Device Specific Status 0	Unsigned	Time not Set	0	Alarm	4	
			Supply Voltage	1	Alarm	4	
			Loop Voltage	2	Alarm	4	
			Battery 1 Voltage	3	Alarm	4	
			Battery 1 Percentage	4	Alarm	4	
			Battery 2 Voltage	5	Alarm	4	
			Battery 2 Percent	6	Alarm	4	
			Undefined	7			
1	Device Specific Status 0	Unsigned	Low-Low Flow	0	Alarm	4	
			Low Flow	1	Alarm	4	
			High Flow	2	Alarm	4	
			High-High Flow	3	Alarm	4	
			Flow Stability Warning	4	Alarm	4	
			K-Factor Error	5	Error	4	
			Meter Factor Error	6	Error	4	
			Bent Blade	7	Error	4	
2	Device Specific Status 0	Unsigned	Missing Blade	0	Error	4	
			Erratic Signal	1	Error	4	
			Replace Kit	2	Alarm	4	
			Undefined	3-7			
3	Device Specific Status 0	Unsigned	User 1 Alarm	0	Alarm	4	
			User 2 Alarm	1	Alarm	4	
			User 3 Alarm	2	Alarm	4	
			User 4 Alarm	3	Alarm	4	
			User 5 Alarm	4	Alarm	4	
			User 6 Alarm	5	Alarm	4	
			User 7 Alarm	6	Alarm	4	
			User 8 Alarm	7	Alarm	4	
4	Device Specific Status 0	Unsigned	Undefined	0-7			
5	Device Specific Status 0	Unsigned	Undefined	0-7			

TABLE D.9—COMMAND #48 RESPONSE DATA BYTES							
Byte	Type	Format	Description	Bit	Class	Device Status Bit Set	Extended Status Bit Set
6	Extended Device Status	Unsigned	Maintenance Required	0	Alarm	4	0
			Device Variable Alert	1	Status	4	1
			Critical Power Failure	2	Error	4	2
			Failure	3	Error	4	3
			Out of Specification	4	Error	4	4
			Function Check	5	Error	4	5
			Undefined	6-7			
7	Device Operating Mode	Unsigned	Undefined	0-7			
8	Standardized Status 0	Unsigned	Simulation Active	0	Status	4	
			Non-Volatile Memory Failure	1	Error	4	
			Volatile Memory Defect	2	Error	4	
			Watchdog Reset Executed	3	Error	4	
			Voltage Conditions out of Range	4	Alarm	4	
			Environmental Conditions out of Range	5	Alarm	4	
			Electronic Failure	6	Error	4	
			Undefined	7			
9	Standardized Status 1	Unsigned	Status Simulation Active	0	Status	4	
			Discrete Variable Simulation Active	1	Status	4	
			Event Notification Overflow	2	Alarm	4	
			Battery or Power Supply Needs Maintenance	3	Alarm	4	
			Undefined	4-7			

DEVICE-SPECIFIC COMMAND DESCRIPTIONS

COMMAND 128 – READ ALARMS

TABLE D.10—#128 REQUEST DATA BYTES

Byte	Format	Description
0	None	N/A

TABLE D.11—#128 RESPONSE DATA BYTES

Byte	Format	Description	Bit
0 - 1	Unsigned	System Status Code: Acknowledged	Table D.12
2 - 3	Unsigned	System Status Code for Current Day	
4 - 5	Unsigned	System Status Code for Current Interval	
6 - 7	Unsigned	System Status Code for Current Month	
8 - 9	Unsigned	System Status Code for Current Polling	
10 - 11	Unsigned	System Status Code: Acknowledged Previously	
12 - 13	Unsigned	System Status Code for Previous Day	
14 - 15	Unsigned	System Status Code for Previous Interval	
16 - 17	Unsigned	System Status Code for Previous Month	
18 - 19	Unsigned	System Status Code for Previous Polling	
20 - 21	Unsigned	Turbine Status Code: Acknowledged	Table D.13
22 - 23	Unsigned	Turbine Status Code for Current Day	
24 - 25	Unsigned	Turbine Status Code for Current Interval	
26 - 27	Unsigned	Turbine Status Code for Current Month	
28 - 29	Unsigned	Turbine Status Code for Current Polling	
30 - 31	Unsigned	Turbine Status Code: Acknowledged Previously	
32 - 33	Unsigned	Turbine Status Code for Previous Day	
34 - 35	Unsigned	Turbine Status Code for Previous Interval	
36 - 37	Unsigned	Turbine Status Code for Previous Month	
38 - 39	Unsigned	Turbine Status Code for Previous Polling	
40 - 41	Unsigned	User Status Code: Acknowledged	Table D.14
42 - 43	Unsigned	User Status Code for Current Day	
44 - 45	Unsigned	User Status Code for Current Interval	
46 - 47	Unsigned	User Status Code for Current Month	
48 - 49	Unsigned	User Status Code for Current Polling	
50 - 51	Unsigned	User Status Code: Acknowledged Previously	
52 - 53	Unsigned	User Status Code for Previous Day	
54 - 55	Unsigned	User Status Code for Previous Interval	
56 - 57	Unsigned	User Status Code for Previous Month	
58 - 59	Unsigned	User Status Code for Previous Polling	

TABLE D.12—#128 SYSTEM STATUS CODES (16-BIT)	
Bit	Description
0	Time Not Set
1	Supply Voltage
2	Loop Voltage
3	Battery 1 Voltage
4	Battery 1 Percentage
5	Battery 2 Voltage
6	Battery 2 Percentage
7-15	Reserved

TABLE D.13—#128 TURBINE STATUS CODES (16-BIT)	
Bit	Description
0	Low-Low Flow
1	Low Flow
2	High Flow
3	High-High Flow
4	Flow Stability Warning
5	K-Factor Error
6	Meter Factor Error
7	Bent Blade Error
8	Missing Blade Error
9	Erratic Signal Error
10	Replace Kit
11-15	Reserved

TABLE D.14—#128 USER STATUS CODES (16-BIT)	
Bit	Description
0	User 1 Alarm
1	User 2 Alarm
2	User 3 Alarm
3	User 4 Alarm
4	User 5 Alarm
5	User 6 Alarm
6	User 7 Alarm
7	User 8 Alarm
8-15	Reserved

TABLE D.15—#128 COMMAND-SPECIFIC RESPONSE CODES		
Code	Class	Description
0	Success	No Command-Specific Errors
1 – 127		Undefined

COMMAND 129 – READ POWER

This command reports the values measured for each power source.

TABLE D.16—#129 REQUEST DATA BYTES		
Byte	Format	Description
0	None	N/A

TABLE D.17—#129 RESPONSE DATA BYTES			
Byte	Format	Description	Unit
0 - 3	Float	Voltage from External Input	Table D.76
4 - 7	Reserved	Reserved for Future Use	
8 - 11	Float	Voltage from Battery 1	Table D.76
12 - 15	Float	% of Capacity Remaining in Battery 1	Percent (Unit code 57)
16 - 19	Float	Voltage from Battery 2	Table D.76
20 - 23	Float	% of Capacity Remaining in Battery 2	Percent (Unit code 57)

TABLE D.18—#129 COMMAND-SPECIFIC RESPONSE CODES		
Code	Class	Description
0	Success	No Command-Specific Errors
1 – 127		Undefined

COMMAND 130 – SET WRITE PROTECTION

This command turns on or off the write protection. Write protect prevents write access to the device.

When passwords are enabled, a password is required to change the write protect state.

When passwords are disabled, the password is not validated before accepting the change request for the write protect state.

TABLE D.19—#130 REQUEST DATA BYTES		
Byte	Format	Description
0	Enum	Write Protect. 0 = No, 1 = Yes
1 – 2	Unsigned	Password. 0 to 9999

TABLE D.20—#130 COMMAND-SPECIFIC RESPONSE CODES		
Code	Class	Description
0	Success	No Command-Specific Errors
1		Undefined
2	Data Entry Error	Invalid Selection
3 – 4		Undefined
5	Data Entry Error	Too Few Data Bytes Received
6	Misc Error	Device Specific Error
7 – 15		Undefined
16	Mode Error	Access Restricted

TABLE D.20—#130 COMMAND-SPECIFIC RESPONSE CODES		
Code	Class	Description
17 – 28		Undefined
29	Misc Error	Wrong Password Provided
30 – 127		Undefined

COMMAND 131 – PUBLISH POLLING REGISTERS

This command publishes the current polling registers. Current polling registers are moved to the polling register previous value and then the current polling registers are reset to zero.

TABLE D.21—#131 REQUEST DATA BYTES		
Byte	Format	Description
0	None	N/A

TABLE D.22—#131 RESPONSE DATA BYTES		
Byte	Format	Description
0	None	N/A

TABLE D.23—#131 COMMAND-SPECIFIC RESPONSE CODES		
Code	Class	Description
0	Success	No Command-Specific Errors
1 – 5		Undefined
6	Misc Error	Device Specific Error
7	Mode Error	In Write Protect Mode
8 – 15		Undefined
16	Mode Error	Access Restricted
17 – 31		Undefined
32	Mode Error	Busy
33 – 127		Undefined

COMMAND 132 – CLEAR GRAND TOTAL

This command resets the current running grand total to zero.

TABLE D.24—#132 REQUEST DATA BYTES		
Byte	Format	Description
0	None	N/A

TABLE D.25—#132 RESPONSE DATA BYTES		
Byte	Format	Description
0	None	N/A

TABLE D.26—#132 COMMAND-SPECIFIC RESPONSE CODES		
Code	Class	Description
0	Success	No Command-Specific Errors
1 – 5		Undefined
6	Misc Error	Device Specific Error
7	Mode Error	In Write Protect Mode
8 – 15		Undefined
16	Mode Error	Access Restricted
17 – 31		Undefined
32	Mode Error	Busy
33 – 127		Undefined

COMMAND 133 – READ K-FACTOR CONFIGURATION

This command reads the K-Factor configuration of the device. The K-Factor is a divider applied to the pulses observed in the input channels for calculating the flow information. The units of K-Factor Values are defined in Turbine K-Factor Units ([Table D.74](#)).

The device can use two different K-Factor models for calculation: Linear or Multipoint. See [Command 134 – Write K-Factor Configuration, page D-13](#) for more details.

TABLE D.27—#133 REQUEST DATA BYTES		
Byte	Format	Description
0	None	N/A

TABLE D.28—#133 RESPONSE DATA BYTES			
Byte	Format	Description	Unit
0 - 1	Enum	KFactor Type. 0 = Linear, 1 = Multipoint	
2 - 3	Unsigned	KFactor Number of Points. 2 to 12	
4 - 7	Float	KFactor Linear Value	Table D.74
8 - 11	Float	KFactor Multi-point 01 - Frequency	Hz (Unit Code 38)
12 - 15	Float	KFactor Multi-point 01 - Value	Table D.74
16 - 19	Float	KFactor Multi-point 02 - Frequency	Hz (Unit Code 38)
20 - 23	Float	KFactor Multi-point 02 - Value	Table D.74
24 - 27	Float	KFactor Multi-point 03 - Frequency	Hz (Unit Code 38)
28 - 31	Float	KFactor Multi-point 03 - Value	Table D.74
32 - 35	Float	KFactor Multi-point 04 - Frequency	Hz (Unit Code 38)
36 - 39	Float	KFactor Multi-point 04 - Value	Table D.74
40 - 43	Float	KFactor Multi-point 05 - Frequency	Hz (Unit Code 38)
44 - 47	Float	KFactor Multi-point 05 - Value	Table D.74
48 - 51	Float	KFactor Multi-point 06 - Frequency	Hz (Unit Code 38)
52 - 55	Float	KFactor Multi-point 06 - Value	Table D.74
56 - 59	Float	KFactor Multi-point 07 - Frequency	Hz (Unit Code 38)
60 - 63	Float	KFactor Multi-point 07 - Value	Table D.74
64 - 67	Float	KFactor Multi-point 08 - Frequency	Hz (Unit Code 38)

TABLE D.28—#133 RESPONSE DATA BYTES			
Byte	Format	Description	Unit
68 - 71	Float	KFactor Multi-point 08 - Value	Table D.74
72 - 75	Float	KFactor Multi-point 09 - Frequency	Hz (Unit Code 38)
76 - 79	Float	KFactor Multi-point 09 - Value	Table D.74
80 - 83	Float	KFactor Multi-point 10 - Frequency	Hz (Unit Code 38)
84 - 87	Float	KFactor Multi-point 10 - Value	Table D.74
88 - 91	Float	KFactor Multi-point 11 - Frequency	Hz (Unit Code 38)
92 - 95	Float	KFactor Multi-point 11 - Value	Table D.74
96 - 99	Float	KFactor Multi-point 12 - Frequency	Hz (Unit Code 38)
100 - 103	Float	KFactor Multi-point 12 - Value	Table D.74

TABLE D.29—#133 COMMAND-SPECIFIC RESPONSE CODES		
Code	Class	Description
0	Success	No Command-Specific Errors
1 - 127		Undefined

COMMAND 134 – WRITE K-FACTOR CONFIGURATION

This command writes the K-Factor configuration of the device. The K-Factor is a divider applied to the pulses observed in the input channels for calculating the flow information. K-Factor units of K-Factor Values are defined in [Table 76](#).

The device can use either of two K-Factor types for calculation: Linear or Multipoint. The selection is made by changing the KFactor Type.

When a Linear K-Factor is selected, the K-Factor Linear Value must be configured. No other parameters are used for calculation of flow.

When a Multipoint K-Factor is selected, 2 to 12 calibration points can be used for calculating flow. This number is specified as the KFactor Number of Points, i.e. If the KFactor Number of Points is set to 5, KFactor Multipoint 01 to 05 value and frequencies must be configured.

Upon receiving the write command, the device will sort the calibration points based on frequency. The device determines the K-Factor Value to be used for flow calculation based on the frequency observed at the input channel.

TABLE D.30—#134 REQUEST DATA BYTES			
Byte	Format	Description	Unit
0 - 1	Enum	KFactor Type. 0 = Linear, 1 = Multipoint	
2 - 3	Unsigned	KFactor Number of Points. 2 to 12	
4 - 7	Float	KFactor Linear Value	Table D.74
8 - 11	Float	KFactor Multi-point 01 - Frequency	Hz (Unit Code 38)
12 - 15	Float	KFactor Multi-point 01 - Value	Table D.74
16 - 19	Float	KFactor Multi-point 02 - Frequency	Hz (Unit Code 38)
20 - 23	Float	KFactor Multi-point 02 - Value	Table D.74
24 - 27	Float	KFactor Multi-point 03 - Frequency	Hz (Unit Code 38)
28 - 31	Float	KFactor Multi-point 03 - Value	Table D.74

TABLE D.30—#134 REQUEST DATA BYTES			
Byte	Format	Description	Unit
32 - 35	Float	KFactor Multi-point 04 - Frequency	Hz (Unit Code 38)
36 - 39	Float	KFactor Multi-point 04 - Value	Table D.74
40 - 43	Float	KFactor Multi-point 05 - Frequency	Hz (Unit Code 38)
44 - 47	Float	KFactor Multi-point 05 - Value	Table D.74
48 - 51	Float	KFactor Multi-point 06 - Frequency	Hz (Unit Code 38)
52 - 55	Float	KFactor Multi-point 06 - Value	Table D.74
56 - 59	Float	KFactor Multi-point 07 - Frequency	Hz (Unit Code 38)
60 - 63	Float	KFactor Multi-point 07 - Value	Table D.74
64 - 67	Float	KFactor Multi-point 08 - Frequency	Hz (Unit Code 38)
68 - 71	Float	KFactor Multi-point 08 - Value	Table D.74
72 - 75	Float	KFactor Multi-point 09 - Frequency	Hz (Unit Code 38)
76 - 79	Float	KFactor Multi-point 09 - Value	Table D.74
80 - 83	Float	KFactor Multi-point 10 - Frequency	Hz (Unit Code 38)
84 - 87	Float	KFactor Multi-point 10 - Value	Table D.74
88 - 91	Float	KFactor Multi-point 11 - Frequency	Hz (Unit Code 38)
92 - 95	Float	KFactor Multi-point 11 - Value	Table D.74
96 - 99	Float	KFactor Multi-point 12 - Frequency	Hz (Unit Code 38)
100 - 103	Float	KFactor Multi-point 12 - Value	Table D.74

TABLE D.31—#134 RESPONSE DATA BYTES			
Byte	Format	Description	Unit
0 - 1	Enum	KFactor Type. 0 = Linear, 1 = Multipoint	
2 - 3	Unsigned	KFactor Number of Points. 2 to 12	
4 - 7	Float	KFactor Linear Value	Table D.74
8 - 11	Float	KFactor Multi-point 01 - Frequency	Hz (Unit Code 38)
12 - 15	Float	KFactor Multi-point 01 - Value	Table D.74
16 - 19	Float	KFactor Multi-point 02 - Frequency	Hz (Unit Code 38)
20 - 23	Float	KFactor Multi-point 02 - Value	Table D.74
24 - 27	Float	KFactor Multi-point 03 - Frequency	Hz (Unit Code 38)
28 - 31	Float	KFactor Multi-point 03 - Value	Table D.74
32 - 35	Float	KFactor Multi-point 04 - Frequency	Hz (Unit Code 38)
36 - 39	Float	KFactor Multi-point 04 - Value	Table D.74
40 - 43	Float	KFactor Multi-point 05 - Frequency	Hz (Unit Code 38)
44 - 47	Float	KFactor Multi-point 05 - Value	Table D.74
48 - 51	Float	KFactor Multi-point 06 - Frequency	Hz (Unit Code 38)
52 - 55	Float	KFactor Multi-point 06 - Value	Table D.74
56 - 59	Float	KFactor Multi-point 07 - Frequency	Hz (Unit Code 38)
60 - 63	Float	KFactor Multi-point 07 - Value	Table D.74
64 - 67	Float	KFactor Multi-point 08 - Frequency	Hz (Unit Code 38)
68 - 71	Float	KFactor Multi-point 08 - Value	Table D.74
72 - 75	Float	KFactor Multi-point 09 - Frequency	Hz (Unit Code 38)

TABLE D.31—#134 RESPONSE DATA BYTES

Byte	Format	Description	Unit
76 - 79	Float	KFactor Multi-point 09 - Value	Table D.74
80 - 83	Float	KFactor Multi-point 10 - Frequency	Hz (Unit Code 38)
84 - 87	Float	KFactor Multi-point 10 - Value	Table D.74
88 - 91	Float	KFactor Multi-point 11 - Frequency	Hz (Unit Code 38)
92 - 95	Float	KFactor Multi-point 11 - Value	Table D.74
96 - 99	Float	KFactor Multi-point 12 - Frequency	Hz (Unit Code 38)
100 - 103	Float	KFactor Multi-point 12 - Value	Table D.74

TABLE D.32—#134 COMMAND-SPECIFIC RESPONSE CODES

Code	Class	Description
0	Success	No Command-Specific Errors
1 – 2		Undefined
3	Data Entry Error	Passed Parameter Too Large
4	Data Entry Error	Passed Parameter Too Small
5	Data Entry Error	Too Few Data Bytes Received
6	Misc Error	Device Specific Error
7	Mode Error	In Write Protect Mode
8 – 15		Undefined
16	Mode Error	Access Restricted
17 – 31		Undefined
32	Mode Error	Busy
33 – 127		Undefined

COMMAND 135 – READ METER FACTOR CONFIGURATION

This command reads the meter factor configuration of the device. The meter factor is a multiplier applied to the flow information to compensate for a meter's unique characteristics. The meter factor is scaler value without any units associated with it. Meter factors allow operators to adjust calibration over time without overwriting a meter's original factory-issued K-factor.

The device can use either of two meter factor types for compensating flow: Linear or Multipoint, or put the meter factor in a de-activated state when no compensation is desired.

See Command 136 for more details.

TABLE D.33—#135 REQUEST DATA BYTES

Byte	Format	Description
0	None	N/A

TABLE D.34—#135 RESPONSE DATA BYTES			
Byte	Format	Description	Unit
0 - 1	Enum	MFactor Type. 0 = Linear, 1 = Multipoint, 2 = Deactivated	
2 - 3	Unsigned	MFactor Number of Points. 2 to 12	
4 - 7	Float	MFactor Linear Value	No Unit
8 - 11	Float	MFactor Multipoint 01 - Frequency	Hz (Unit Code 38)
12 - 15	Float	MFactor Multipoint 01 - Value	No Unit
16 - 19	Float	MFactor Multipoint 02 - Frequency	Hz (Unit Code 38)
20 - 23	Float	MFactor Multipoint 02 - Value	No Unit
24 - 27	Float	MFactor Multipoint 03 - Frequency	Hz (Unit Code 38)
28 - 31	Float	MFactor Multipoint 03 - Value	No Unit
32 - 35	Float	MFactor Multipoint 04 - Frequency	Hz (Unit Code 38)
36 - 39	Float	MFactor Multipoint 04 - Value	No Unit
40 - 43	Float	MFactor Multipoint 05 - Frequency	Hz (Unit Code 38)
44 - 47	Float	MFactor Multipoint 05 - Value	No Unit
48 - 51	Float	MFactor Multipoint 06 - Frequency	Hz (Unit Code 38)
52 - 55	Float	MFactor Multipoint 06 - Value	No Unit
56 - 59	Float	MFactor Multipoint 07 - Frequency	Hz (Unit Code 38)
60 - 63	Float	MFactor Multipoint 07 - Value	No Unit
64 - 67	Float	MFactor Multipoint 08 - Frequency	Hz (Unit Code 38)
68 - 71	Float	MFactor Multipoint 08 - Value	No Unit
72 - 75	Float	MFactor Multipoint 09 - Frequency	Hz (Unit Code 38)
76 - 79	Float	MFactor Multipoint 09 - Value	No Unit
80 - 83	Float	MFactor Multipoint 10 - Frequency	Hz (Unit Code 38)
84 - 87	Float	MFactor Multipoint 10 - Value	No Unit
88 - 91	Float	MFactor Multipoint 11 - Frequency	Hz (Unit Code 38)
92 - 95	Float	MFactor Multipoint 11 - Value	No Unit
96 - 99	Float	MFactor Multipoint 12 - Frequency	Hz (Unit Code 38)
100 - 103	Float	MFactor Multipoint 12 - Value	No Unit

TABLE D.35—#135 COMMAND-SPECIFIC RESPONSE CODES		
Code	Class	Description
0	Success	No Command-Specific Errors
1 - 127		Undefined

COMMAND 136 – WRITE METER FACTOR CONFIGURATION

This command writes the meter factor configuration of the device. The meter factor is a multiplier applied to the flow information to compensate for a meter's unique characteristics. The meter factor is a scaler value without units. Meter factors allow operators to adjust calibration over time without overwriting a meter's original factory-issued K-factor.

The device can use either of two meter factor types for compensating flow—Linear or Multipoint—or put the meter factor in a de-activated state when no compensation is desired. The selection is made by changing the MFactor Type.

When a Linear Meter Factor is used, the MFactor Linear Value must be configured. No other parameters are used for compensation of flow.

When a Multipoint MFactor is used, 2 to 12 calibration points may be used for compensating the flow calculation. This number is specified as the MFactor Number of Points. i.e. If the Number of MFactor Points is set to 7, MFactor Multipoint 01 - 07 values and frequencies must be configured.

Upon receiving the write command, the device will sort the MFactor points based on frequency. The device determines the meter factor value to be applied to the flow calculation based on the frequency observed at the input channel.

TABLE D.36—#136 REQUEST DATA BYTES

Byte	Format	Description	Unit
0 - 1	Enum	MFactor Type. 0 = Linear, 1 = Multipoint, 2 = Deactivated	
2 - 3	Unsigned	MFactor Number of Points. 2 to 12	
4 - 7	Float	MFactor Linear Value	No Unit
8 - 11	Float	MFactor Multipoint 01 - Frequency	Hz (Unit Code 38)
12 - 15	Float	MFactor Multipoint 01 - Value	No Unit
16 - 19	Float	MFactor Multipoint 02 - Frequency	Hz (Unit Code 38)
20 - 23	Float	MFactor Multipoint 02 - Value	No Unit
24 - 27	Float	MFactor Multipoint 03 - Frequency	Hz (Unit Code 38)
28 - 31	Float	MFactor Multipoint 03 - Value	No Unit
32 - 35	Float	MFactor Multipoint 04 - Frequency	Hz (Unit Code 38)
36 - 39	Float	MFactor Multipoint 04 - Value	No Unit
40 - 43	Float	MFactor Multipoint 05 - Frequency	Hz (Unit Code 38)
44 - 47	Float	MFactor Multipoint 05 - Value	No Unit
48 - 51	Float	MFactor Multipoint 06 - Frequency	Hz (Unit Code 38)
52 - 55	Float	MFactor Multipoint 06 - Value	No Unit
56 - 59	Float	MFactor Multipoint 07 - Frequency	Hz (Unit Code 38)
60 - 63	Float	MFactor Multipoint 07 - Value	No Unit
64 - 67	Float	MFactor Multipoint 08 - Frequency	Hz (Unit Code 38)
68 - 71	Float	MFactor Multipoint 08 - Value	No Unit
72 - 75	Float	MFactor Multipoint 09 - Frequency	Hz (Unit Code 38)
76 - 79	Float	MFactor Multipoint 09 - Value	No Unit
80 - 83	Float	MFactor Multipoint 10 - Frequency	Hz (Unit Code 38)
84 - 87	Float	MFactor Multipoint 10 - Value	No Unit
88 - 91	Float	MFactor Multipoint 11 - Frequency	Hz (Unit Code 38)
92 - 95	Float	MFactor Multipoint 11 - Value	No Unit

TABLE D.36—#136 REQUEST DATA BYTES

Byte	Format	Description	Unit
96 - 99	Float	MFactor Multipoint 12 - Frequency	Hz (Unit Code 38)
100 - 103	Float	MFactor Multipoint 12 - Value (No Unit)	No Unit

TABLE D.37—#136 RESPONSE DATA BYTES

Byte	Format	Description	Unit
0 - 1	Enum	MFactor Type. 0 = Linear, 1 = Multipoint, 2 = Deactivated	
2 - 3	Unsigned	MFactor Number of Points. 2 to 12	
4 - 7	Float	MFactor Linear Value	No Unit
8 - 11	Float	MFactor Multipoint 01 - Frequency	Hz (Unit Code 38)
12 - 15	Float	MFactor Multipoint 01 - Value	No Unit
16 - 19	Float	MFactor Multipoint 02 - Frequency	Hz (Unit Code 38)
20 - 23	Float	MFactor Multipoint 02 - Value	No Unit
24 - 27	Float	MFactor Multipoint 03 - Frequency	Hz (Unit Code 38)
28 - 31	Float	MFactor Multipoint 03 - Value	No Unit
32 - 35	Float	MFactor Multipoint 04 - Frequency	Hz (Unit Code 38)
36 - 39	Float	MFactor Multipoint 04 - Value	No Unit
40 - 43	Float	MFactor Multipoint 05 - Frequency	Hz (Unit Code 38)
44 - 47	Float	MFactor Multipoint 05 - Value	No Unit
48 - 51	Float	MFactor Multipoint 06 - Frequency	Hz (Unit Code 38)
52 - 55	Float	MFactor Multipoint 06 - Value	No Unit
56 - 59	Float	MFactor Multipoint 07 - Frequency	Hz (Unit Code 38)
60 - 63	Float	MFactor Multipoint 07 - Value	No Unit
64 - 67	Float	MFactor Multipoint 08 - Frequency	Hz (Unit Code 38)
68 - 71	Float	MFactor Multipoint 08 - Value	No Unit
72 - 75	Float	MFactor Multipoint 09 - Frequency	Hz (Unit Code 38)
76 - 79	Float	MFactor Multipoint 09 - Value	No Unit
80 - 83	Float	MFactor Multipoint 10 - Frequency	Hz (Unit Code 38)
84 - 87	Float	MFactor Multipoint 10 - Value	No Unit
88 - 91	Float	MFactor Multipoint 11 - Frequency	Hz (Unit Code 38)
92 - 95	Float	MFactor Multipoint 11 - Value	No Unit
96 - 99	Float	MFactor Multipoint 12 - Frequency	Hz (Unit Code 38)
100 - 103	Float	MFactor Multipoint 12 - Value (No Unit)	No Unit

TABLE D.38—#136 COMMAND-SPECIFIC RESPONSE CODES

Code	Class	Description
0	Success	No Command-Specific Errors
1 - 2		Undefined
3	Data Entry Error	Passed Parameter Too Large
4	Data Entry Error	Passed Parameter Too Small
5	Data Entry Error	Too Few Data Bytes Received

TABLE D.38—#136 COMMAND-SPECIFIC RESPONSE CODES		
Code	Class	Description
6	Misc Error	Device Specific Error
7	Mode Error	In Write Protect Mode
8 – 15		Undefined
16	Mode Error	Access Restricted
17 – 31		Undefined
32	Mode Error	Busy
33 – 127		Undefined

COMMAND 137 – READ INPUT CHANNEL CONFIGURATION AND METER CHARACTERISTICS

This command reads the current active input channel configuration and meter characteristics.

This command reads the input type, input sensitivity threshold, and sampling period (calculation period of flow). Input frequency (number of pulses) is observed each second and continuously monitored.

The sensitivity setting is useful for filtering out noise from the input signal, especially for turbine inputs.

This command also reads the meter characteristics of a (turbine meter such as the number of blades, body diameter, and flow range).

TABLE D.39—#137 REQUEST DATA BYTES		
Byte	Format	Description
0	None	N/A

TABLE D.40—#137 RESPONSE DATA BYTES			
Byte	Format	Description	Unit
0 - 1	Enum	Input Type. 0 = Digital Pulse, 1 = Turbine Magnetic Pickup, 2 = Contact Closure	
2 - 3	Enum	Sensitivity Threshold. 0 = Low, 1 = Medium, 2 = High, 3 = Max	
4 - 5	Unsigned	Number of Blades 2 to 12	
6	Unsigned	Body Size Unit Code	Table 79
7 - 10	Float	Body Size	Table 79
11	Unsigned	Flow Rate Range Unit Code	Table 74
12 - 15	Float	Flow Rate Range: Low	Table 74
16 - 19	Float	Flow Rate Range: High	Table 74
20 - 21	Unsigned	Sample Period. 1 to 4320	Seconds (Unit Code 51)

TABLE D.41—#137 COMMAND-SPECIFIC RESPONSE CODES		
Code	Class	Description
0	Success	No Command-Specific Errors
1 – 127		Undefined

COMMAND 138 – WRITE INPUT CHANNEL CONFIGURATION AND METER CHARACTERISTICS

This command writes the input channel configuration and meter characteristics.

The command writes the input type, input sensitivity threshold, and sampling period (calculation period of flow). Input frequency (number of pulses) is observed each second and continuously monitored.

The sensitivity setting is useful for filtering out noise from the input signal, especially for turbine inputs.

The input type is based on the sensor connected to an input channel.

If the input signal is a pulse from a pre-amplifier or a discrete signal from another device, select the Digital Pulse input type.

This command also writes the meter characteristics of a turbine meter such as the number of blades, body size, and flow range.

For turbine input type, the number of blades – a number between 2 and 12 – is required for turbine meter health diagnostics.

The flow rate range must be configured for the meter or sensor connected to the input channel.

TABLE D.42—#138 REQUEST DATA BYTES

Byte	Format	Description	Unit
0 - 1	Enum	Input Type. 0 = Digital Pulse, 1 = Turbine Magnetic Pickup, 2 = Contact Closure	
2 - 3	Enum	Sensitivity Threshold. 0 = Low, 1 = Medium, 2 = High, 3 = Max	
4 - 5	Unsigned	Number of Blades 2 to 12	
6	Unsigned	Body Size Unit Code	Table D.77
7 - 10	Float	Body Size	Table D.77
11	Unsigned	Flow Rate Range Unit Code	Table D.72
12 - 15	Float	Flow Rate Range: Low	Table D.72
16 - 19	Float	Flow Rate Range: High	Table D.72
20 - 21	Unsigned	Sample Period. 1 to 4320	Seconds (Unit Code 51)

TABLE D.43—#138 RESPONSE DATA BYTES

Byte	Format	Description	Unit
0 - 1	Enum	Input Type. 0 = Digital Pulse, 1 = Turbine Magnetic Pickup, 2 = Contact Closure	
2 - 3	Enum	Sensitivity Threshold. 0 = Low, 1 = Medium, 2 = High, 3 = Max	
4 - 5	Unsigned	Number of Blades 2 to 12	
6	Unsigned	Body Size Unit Code	Table D.77
7 - 10	Float	Body Size	Table D.77
11	Unsigned	Flow Rate Range Unit Code	Table D.72
12 - 15	Float	Flow Rate Range: Low	Table D.72
16 - 19	Float	Flow Rate Range: High	Table D.72

TABLE D.43—#138 RESPONSE DATA BYTES

Byte	Format	Description	Unit
20 - 21	Unsigned	Sample Period. 1 to 4320	Seconds (Unit Code 51)

TABLE D.44—#138 COMMAND-SPECIFIC RESPONSE CODES

Code	Class	Description
0	Success	No Command-Specific Errors
1 – 2		Undefined
3	Data Entry Error	Passed Parameter Too Large
4	Data Entry Error	Passed Parameter Too Small
5	Data Entry Error	Too Few Data Bytes Received
6	Misc Error	Device Specific Error
7	Mode Error	In Write Protect Mode
8 – 15		Undefined
16	Mode Error	Access Restricted
17 – 31		Undefined
32	Mode Error	Busy
33 – 127		Undefined

COMMAND 139 – READ RUNTIME

This command reads the runtime values for daily, hourly, monthly, polling, previous day, previous hour, previous month, and previous polling intervals in seconds.

TABLE D.45—#139 REQUEST DATA BYTES

Byte	Format	Description
0	None	N/A

TABLE D.46—#139 RESPONSE DATA BYTES

Byte	Format	Description	Unit
0-3	Unsigned	Runtime for Current Day	Seconds (Unit Code 51)
4-7	Unsigned	Runtime for Current Hour	Seconds (Unit Code 51)
8-11	Unsigned	Runtime for Current Month	Seconds (Unit Code 51)
12-15	Unsigned	Runtime for Current Polling Period	Seconds (Unit Code 51)
16-19	Unsigned	Runtime for Previous Day	Seconds (Unit Code 51)
20-23	Unsigned	Runtime for Previous Hour	Seconds (Unit Code 51)
24-27	Unsigned	Runtime for Previous Month	Seconds (Unit Code 51)
28-31	Unsigned	Runtime for Previous Polling Period	Seconds (Unit Code 51)

TABLE D.47—#139 COMMAND-SPECIFIC RESPONSE CODES

Code	Class	Description
0	Success	No Command-Specific Errors
1 – 127		Undefined

COMMAND 140 – READ FLOW RATE TRIM DIGITAL TO ANALOG CONVERTER

This command reads the flow rate trim Digital to Analog Converter (DAC) offset and scale values being used. The MC Synergy DAC output can be digitally calibrated to compensate for manufacturing tolerances and drift using 2 points to determine the offset and scale values. Also see common practice commands 45 and 46

TABLE D.48—#140 REQUEST DATA BYTES

Byte	Format	Description
0	None	N/A

TABLE D.49—#140 RESPONSE DATA BYTES

Byte	Format	Description
0-3	Float	Offset for Flow Rate Trim DAC
4-7	Float	Scale for Flow Rate Trim DAC

TABLE D.50—#140 COMMAND-SPECIFIC RESPONSE CODES

Code	Class	Description
0	Success	No Command-Specific Errors
1 – 127		Undefined

COMMAND 141 – RESET ANALOG OUTPUT TRIM

This command resets the analog DAC trim settings to default values. The MC Synergy DAC output can be digitally calibrated to compensate for manufacturing tolerances and drift using two points to determine the offset and scale values.

TABLE D.51—#141 REQUEST DATA BYTES

Byte	Format	Description
0	None	N/A

TABLE D.52—#141 RESPONSE DATA BYTES

Byte	Format	Description
0	None	N/A

TABLE D.53—#141 COMMAND-SPECIFIC RESPONSE CODES

Code	Class	Description
0	Success	No Command-Specific Errors
1 – 5		Undefined
6	Misc Error	Device Specific Error
7	Mode Error	In Write Protect Mode
8 – 15		Undefined
16	Mode Error	Access Restricted
17 – 31		Undefined
32	Mode Error	Busy
33 – 127		Undefined

COMMAND 142 – READ SITE / WELL NAME

This command reads the Site / Well Name stored in the device.

TABLE D.54—#142 REQUEST DATA BYTES		
Byte	Format	Description
0	None	N/A

TABLE D.55—#142 RESPONSE DATA BYTES		
Byte	Format	Description
0-19	Latin-1	Name of Site / Well

TABLE D.56—#140 COMMAND-SPECIFIC RESPONSE CODES		
Code	Class	Description
0	Success	No Command-Specific Errors
1 – 127		Undefined

COMMAND 143 – WRITE SITE / WELL NAME

TABLE D.57—#143 REQUEST DATA BYTES		
Byte	Format	Description
0-19	Latin-1	Name of Site / Well

TABLE D.58—#143 RESPONSE DATA BYTES		
Byte	Format	Description
0-19	Latin-1	Name of Site / Well

TABLE D.59—#143 COMMAND-SPECIFIC RESPONSE CODES		
Code	Class	Description
0	Success	No Command-Specific Errors
1 – 2		Undefined
3	Data Entry Error	Passed Parameter Too Large
4	Data Entry Error	Passed Parameter Too Small
5	Data Entry Error	Too Few Data Bytes Received
6	Misc Error	Device Specific Error
7	Mode Error	In Write Protect Mode
8 – 15		Undefined
16	Mode Error	Access Restricted
17 – 31		Undefined
32	Mode Error	Busy
33 – 127		Undefined

COMMAND 144 – READ PASSWORD PROTECTION STATUS**TABLE D.60—#144 REQUEST DATA BYTES**

Byte	Format	Description
0	None	N/A

TABLE D.61—#144 RESPONSE DATA BYTES

Byte	Format	Description
0	Enum	Password Protection Status. 0 = Disabled, 1 = Enabled
1	Enum	Write Protection Enabled. 0 = No, 1 = Yes
2	Enum	Device Arm Enabled. 0 = No, 1 = Yes

TABLE D.62—#144 COMMAND-SPECIFIC RESPONSE CODES

Code	Class	Description
0	Success	No Command-Specific Errors
1 – 127		Undefined

COMMAND 145 – CHANGE PASSWORD

This command allows the user to update the password status and change the password. It also controls access to write protection which will prevent write of any new configuration to the device via a HART interface.

- To change the password, send command 145 along with Password Operation “2”, the current password, and the new password.
- To enable the password protection, send command 145 along with Password Operation “1” and the current password. (The New Password value can remain 0.)
- To disable the password protection, send command 145 along with Password Operation “0” and the current password. (The New Password value can remain 0.)

The range of values supported for a valid password is 0000 to 9999.

TABLE D.63—#145 REQUEST DATA BYTES

Byte	Format	Description
0	Enum	Password Operation. 0 = Disable Password Protection, 1 = Enable Password Protection, 2 = Change Password
1-2	Unsigned	Password. 0 to 9999
3-4	Unsigned	New Password. 0 to 9999

TABLE D.64—#145 RESPONSE DATA BYTES

Byte	Format	Description
0	Enum	Password Operation. 0 = Disable Password Protection, 1 = Enable Password Protection, 2 = Change Password
1-2	Unsigned	Password. 0 to 9999
3-4	Unsigned	New Password. 0 to 9999

TABLE D.65—#145 COMMAND-SPECIFIC RESPONSE CODES		
Code	Class	Description
0	Success	No Command-Specific Errors
1 – 4		Undefined
5	Data Entry Error	Too Few Data Bytes Received
6	Misc Error	Device Specific Error
7 – 15		Undefined
16	Mode Error	Access Restricted
17 – 28		Undefined
29	Mode Error	Wrong Password Provided
30 – 127		Undefined

COMMAND 146 – READ DISPLAY UNIT CONFIGURATION

This command reads the current Display Unit Configuration.

The Override Display Units Configuration forces the use of the display unit configured with HART.

TABLE D.66—#146 REQUEST DATA BYTES		
Byte	Format	Description
0	None	N/A

TABLE D.67—#146 RESPONSE DATA BYTES		
Byte	Format	Description
0-1	Enum	Override Display Units Configuration. 0 = No, 1 = Yes

TABLE D.68—#146 COMMAND-SPECIFIC RESPONSE CODES		
Code	Class	Description
0	Success	No Command-Specific Errors
1 – 127		Undefined

COMMAND 147 – WRITE DISPLAY UNIT CONFIGURATION

This command writes the current Display Unit Configuration.

The Override Display Units Configuration forces the use of the display unit configured with HART.

TABLE D.69—#147 REQUEST DATA BYTES		
Byte	Format	Description
0-1	Enum	Override Display Units Configuration. 0 = No, 1 = Yes

TABLE D.70—#147 RESPONSE DATA BYTES		
Byte	Format	Description
0-1	Enum	Override Display Units Configuration. 0 = No, 1 = Yes

TABLE D.71—#137 COMMAND-SPECIFIC RESPONSE CODES		
Code	Class	Description
0	Success	No Command-Specific Errors
1 – 2		Undefined
3	Data Entry Error	Passed Parameter Too Large
4	Data Entry Error	Passed Parameter Too Small
5	Data Entry Error	Too Few Data Bytes Received
6	Misc Error	Device Specific Error
7	Mode Error	In Write Protect Mode
8 – 15		Undefined
16	Mode Error	Access Restricted
17 – 31		Undefined
32	Mode Error	Busy
33 – 127		Undefined

UNIT SETS

This section shows the unit sets that are supported by the MC Synergy totalizer and is useful for decoding and updating the units configured on the device. The units for the Device variables are programmed using the Common Practice HART commands. The unit codes are not returned for these variables when accessed using the Device Specific commands.

FLOW RATE UNIT CODES

This is a sub-set of the Unit table defined in HART Communication Protocol.

TABLE D.72—FLOW RATE UNIT CODES		
Unit Code	Description	Note
15	cubic feet per minute	
16	gallons per minute	
17	liters per minute	
19	cubic meter per hour	
22	gallons per second	
24	liters per second	
26	cubic feet per second	
27	cubic feet per day	
28	cubic meters per second	
29	cubic meters per day	
130	cubic feet per hour	

TABLE D.72—FLOW RATE UNIT CODES		
Unit Code	Description	Note
131	cubic meters per minute	
132	barrels per second	
133	barrels per minute	
134	barrels per hour	
135	barrels per day	
136	gallons per hour	
138	liters per hour	
235	gallons per day	
240	liters per day	Manufacturer Specific Code

VOLUME UNIT CODES

This is a sub-set of the Unit table defined in HART Communication Protocol.

TABLE D.73—VOLUME UNIT CODES	
Unit Code	Description
40	gallons
41	liters
43	cubic meters
46	barrels
112	cubic feet

K-FACTOR UNIT CODES

These are manufacturer-specific codes.

TABLE D.74—K-FACTOR UNIT CODES	
Unit Code	Description
242	pulses per gallon
243	pulses per barrel
244	pulses per cubic meter
245	pulses per liter
246	pulses per cubic feet

TEMPERATURE UNIT CODES

This is a sub-set of the Unit table defined in HART Communication Protocol.

TABLE D.75—TEMPERATURE UNIT CODES	
Unit Code	Description
32	degrees Celsius
33	degrees Fahrenheit

TABLE D.75—TEMPERATURE UNIT CODES

Unit Code	Description
34	degrees Rankine
35	kelvin

VOLTAGE UNIT CODES

This is a sub-set of the Unit table defined in HART Communication Protocol.

TABLE D.76—VOLTAGE UNIT CODES

Unit Code	Description
36	millivolts
58	volts

LENGTH UNIT CODES

This is a sub-set of the Unit table defined in HART Communication Protocol.

TABLE D.77—LENGTH UNIT CODES

Unit Code	Description
44	feet
45	meters
47	inches
48	centimeters
49	millimeters

PERFORMANCE

SAMPLING RATES

TABLE D.78—SAMPLING RATES

Channel / Variable	Sampling Rate
Primary Input Channel sample rate	1 sample per second
PV digital value calculation	Depending on Sample Period (Max sampling rate is 1 per second)
SV digital value calculation	Depending on Sample Period (Max sampling rate is 1 per second)
TV digital value calculation	Depending on Sample Period (Max sampling rate is 1 per second)
QV digital value calculation	Depending on Sample Period (Max sampling rate is 1 per second)
Analog output update frequency	1 per second

Note Calculation of flow is based on the sample period configured.

POWER-UP

On power up, the transmitter goes through a self-test procedure ([Self-Test](#)), which takes approximately 5 seconds. During this period, the device will not respond to HART commands, and the analog output is set at 3.8mA.

When the self-test is successfully completed and the first measurement has been made, the PV value is set and the analog output moves to a value representing the measurement. The device will respond to HART commands only after the PV is set.

If the self-test fails, all live measurement data (PV, current and percent of range) are set to “Not A Number.” The analog output is set to the configured malfunction-indicating current. In this state, the device will attempt to respond to HART commands.

Fixed-current mode is cancelled by power loss.

RESET

Command 42 (“Device Reset”) causes the device to reset its microprocessor. The re-start is identical to the normal power-up sequence.

SELF-TEST

The self-test procedure is executed at power-up following Command 42 (“Device Reset”) or following Command 41 (“self-test”). The self-test includes:

- Microprocessor
- Ram
- Program rom
- Configuration storage MEM CHIP
- Digital-to-analog converter
- Basic functional operations

The self-test takes about 5 seconds. During a self-test following a power-up or reset, the analog output is set to 3.8 mA and the device will not respond to HART commands.

During a self-test prompted by a self-test command, the analog output is held at its last value; the device may respond normally to HART commands or may return a “busy” status.

COMMAND RESPONSE TIMES

TABLE D.79—COMMAND RESPONSE TIMES	
	Time
Minimum	3.5 ms
Typical	4.0 ms
Maximum	100 ms

BUSY AND DELAYED RESPONSE

The transmitter may respond with a “busy” status if an additional command is received while a self-test is underway.

A Delayed Response is implemented to respond to the additional command once the device is no longer in a “busy” state.

LONG MESSAGES

The largest data field is the Data Response to Commands 133, 134, 135 and 136 with 105 bytes including the two status bytes.

MODES

A Fixed Current mode is implemented using Command 40.

WRITE PROTECTION

Write protection is provided via software. When the device is not in write protect mode, all commands are available. In write protect mode, no “write” or “command” commands are accepted.

DAMPING

Damping is standard in the MC Synergy totalizer, affecting only the PV and the loop current signal. This functionality is not available through the Device Definition.

CAPABILITIES & DEFAULT CONFIGURATION

CAPABILITY CHECKLIST

TABLE D.80—CAPABILITY CHECKLIST	
Capability	Comment
Manufacturer, Model and Revision	Sensia, MC Synergy Family, 1
Device Type	Transmitter, non-DC-isolated bus device
HART Revision	7.6
Device Description Available	Yes
Number and Type of Sensors	1 (one external)
Number and Type of Actuators	0
Number and Type of Host Side Signals	1: 4 - 20 mA analog
Number of Device Variables	14
Number of Dynamic Variables	4
Mappable Dynamic Variables	Yes (SV, TV, QV)
Number of Common-Practice Commands	27
Number of Device-Specific Commands	20
Bits of Additional Device Status	80
Alternative Operating Modes	No
Burst Mode	Yes
Capture Device Variables	No
Write Protection	Yes

DEFAULT CONFIGURATION

TABLE D.81—DEFAULT CONFIGURATION	
Parameter	Default Value
Lower Range Value	0
Upper Range Value	101
PV Units	gallons per second
Input Type	turbine magnetic pickup
Sensitivity Threshold	Low – 20 mA
Sampling Period	4 seconds
Damping Time Constant	1 second
Write-Protect	Off
Number of Response Preambles	5
Temperature Unit	kelvin
K-Factor Unit	pulses per gallon
Flow Rate Unit	gallons per second
Total Unit	gallon
Length Unit	inch

Scan a QR for

Technical
Support

Customer
Care



[sensiaglobal.com](https://www.sensiaglobal.com)

1-866 7 SENSIA (+1-866-773-6742)

info@sensiaglobal.com

Add intelligent action to your oil & gas solutions

© 2026 SENSIA. All rights reserved.

